

CUT

SC. 120A

BG.

DIAGONAL PAN  
SETUP

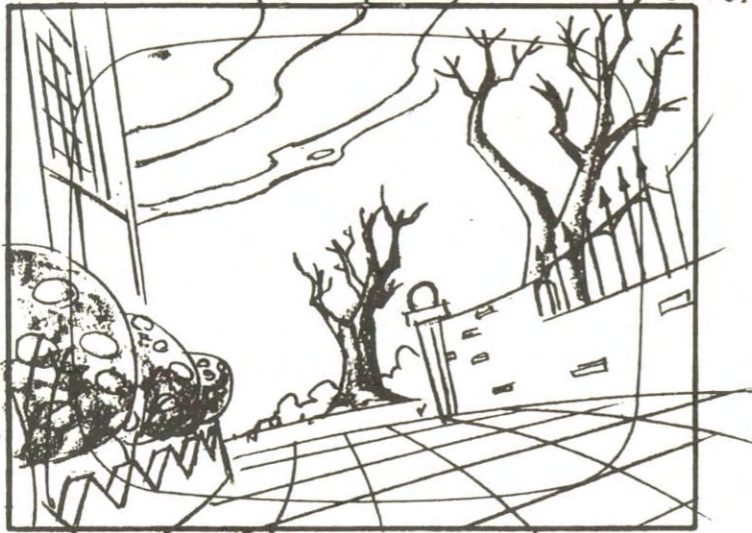

ACTION EXT. DEVIL PATIO - DAY

DIAL

SLG

TRANS

SC. 120A CONT BG.



ACTION MARLOWE RUNS INTO VIEW  
TOWARD CAMERA

DIAL

SLG

TRANS

SC. 120A CONT BG.

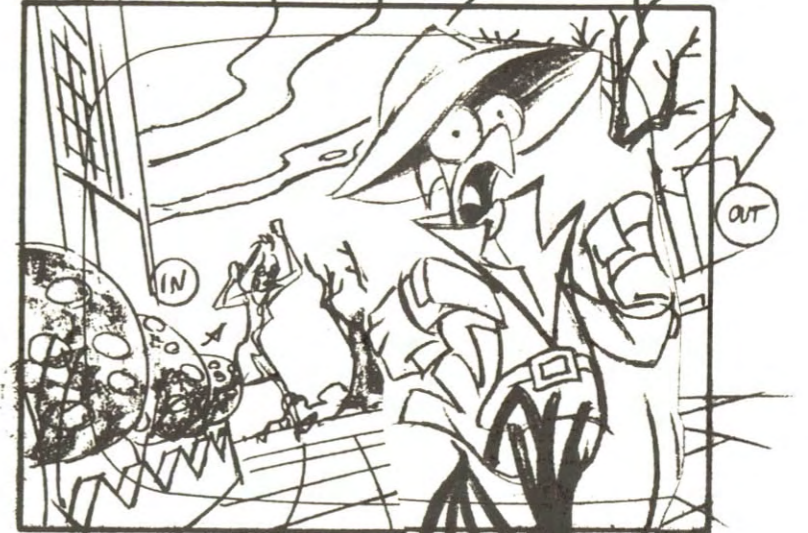

ACTION MARLOWE IN PANIC  
RUNS FROM CAMERA RIGHT, AS  
CRUELLA RUNS INTO VIEW.

DIAL

SLG

TRANS

SC. BG.

SC. 120A CONT BG.

CUT

SC. BG.

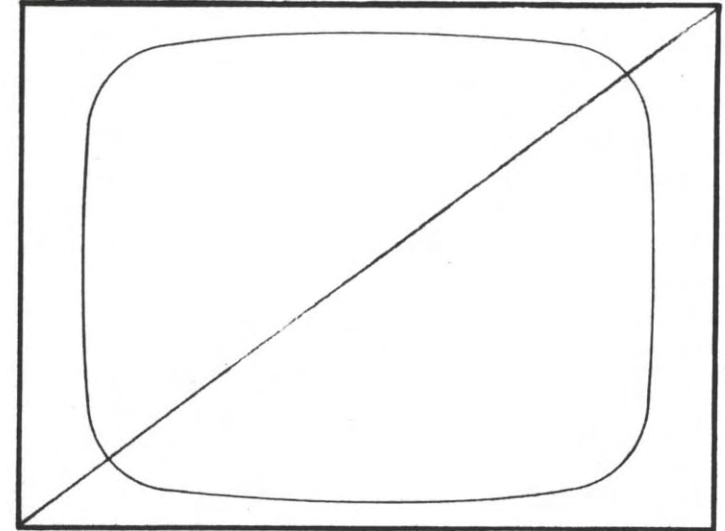
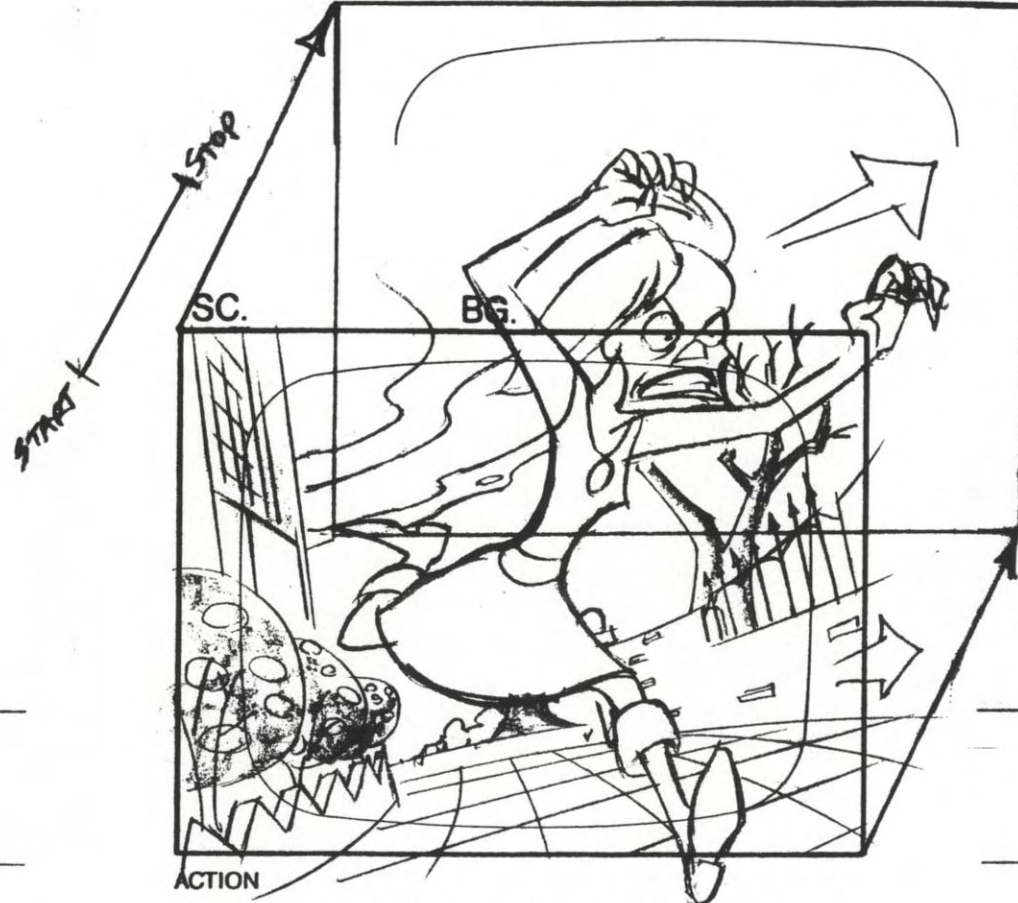

ACTION

ACTION

DIAL

DIAL

SLG

SLG

TRANS

TRANS

ACTION

DIAGONAL PAN WITH CRUELLA AS SHE RUNS TOWARD CAMERA RIGHT. STOP PAN. CRUELLA RUNS O.S.

DIAL



WALT DISNEY PICTURES

CUT

SC. 120 B BG. 4338-999

(INNER TUBE  
MOVED TO FRONT  
OF BOARD)

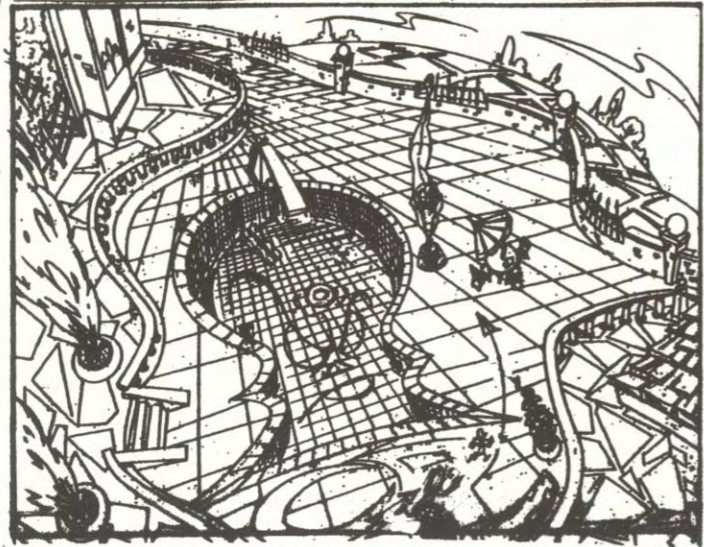

ACTION EXT. DEVIL SWIMMING POOL - DAY  
MARLOWE RUNS INTO VIEW AT FRAME  
BOTTOM, FOLLOWED BY CRUELLA WITH  
HER ARMS OUTSTRETCHED TO GRAB  
MARLOWE.

DIAL  
  
SLG  
  
TRANS

SC. 120 B CONT BG. 4338-999



ACTION TRUCK IN AS CRUELLA CHASES  
MARLOWE AROUND TABLE AND  
TOWARD DIVING BOARD.

DIAL  
  
SLG  
  
TRANS

SC. BG.

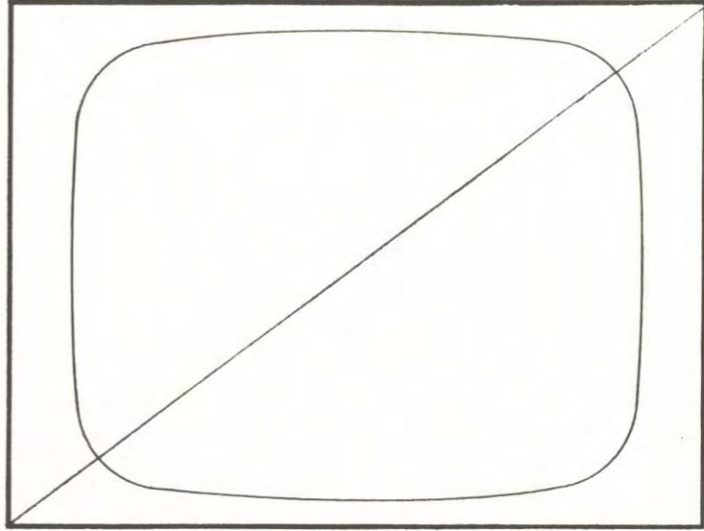

ACTION  
  
DIAL  
  
SLG  
  
TRANS

SC. BG.

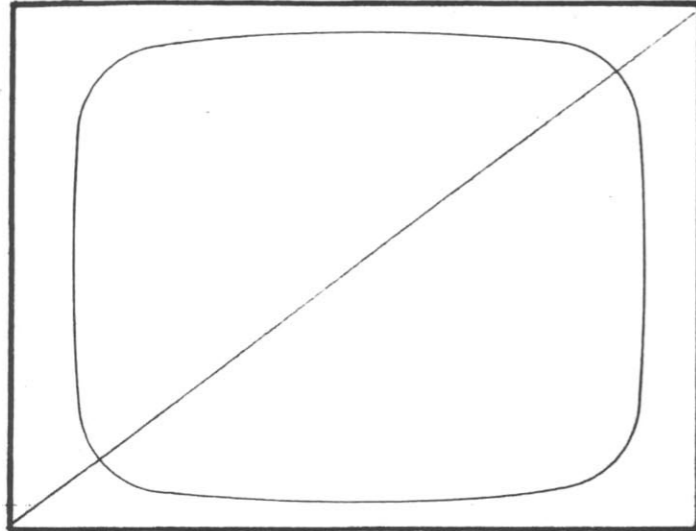

ACTION

DIAL

SLG

TRANS

SC. 120 B CONT BG. 4338-999

(INNER TUBE MOVED TO FRONT OF BOARD)

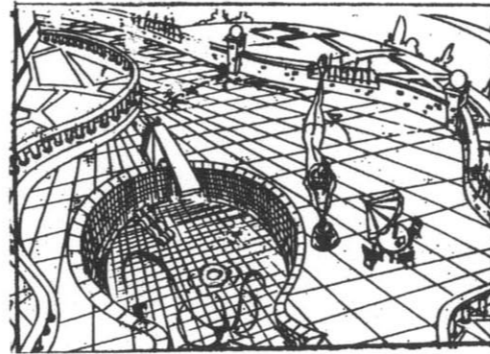

ACTION MARLOWE RUNS TO DIVING BOARD, CRUELLA LAGS BEHIND.

DIAL

SLG

TRANS

SC. 120-C BG.

CUT

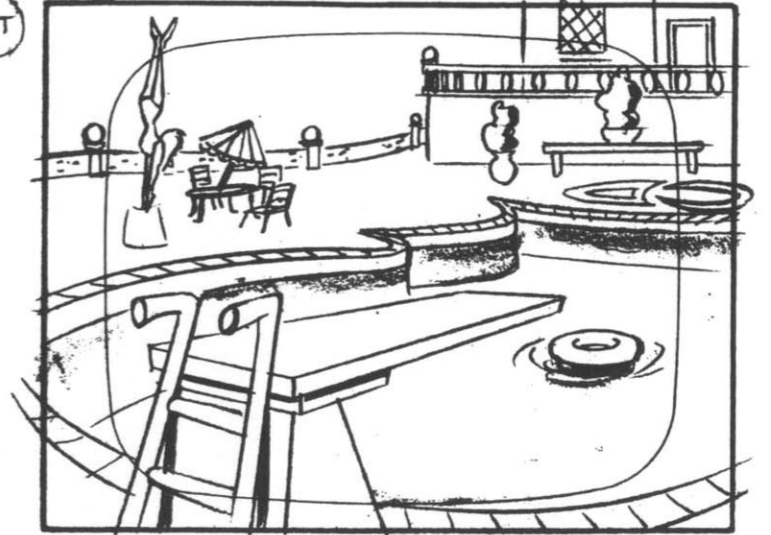

ACTION EXT. SWIMMING POOL - DAY

DIAL

SLG

TRANS



SC. 120-C CONT BG.

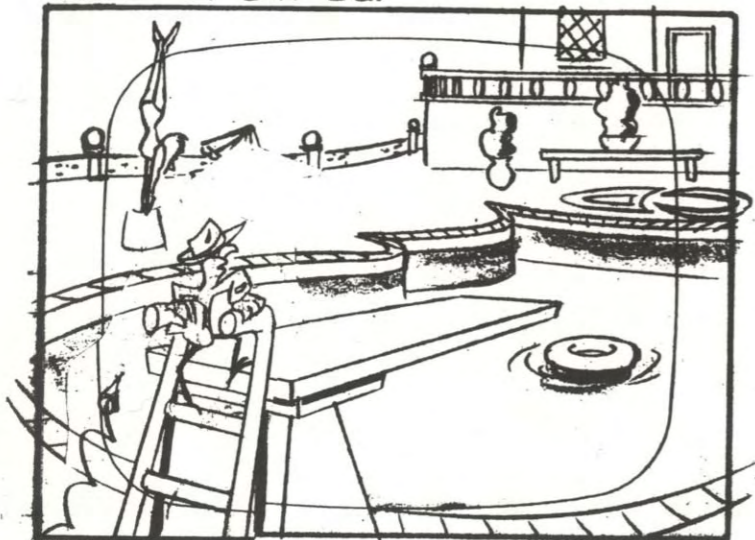

ACTION  
MARLOWE CLIMBS DIVING BOARD LADDER

DIAL

SLG

TRANS

SC. 120-C CONT BG.

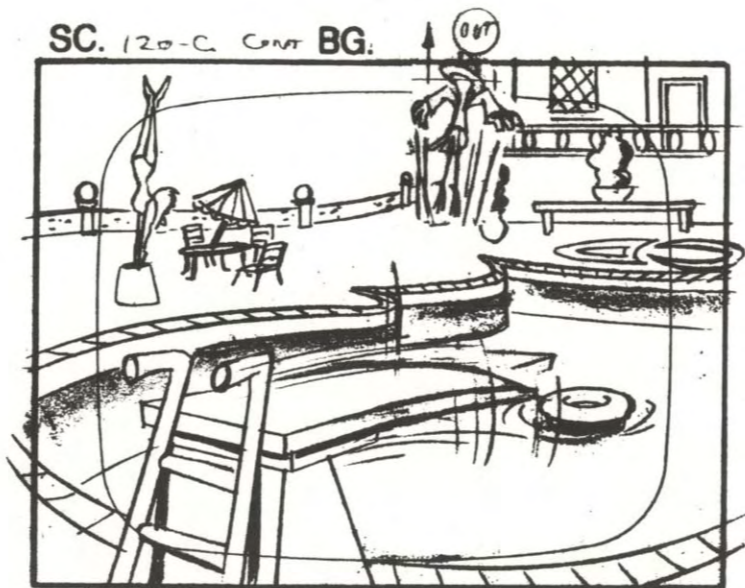

ACTION MARLOWE JUMPS OFF DIVING BOARD  
OUT OF FRAME.

DIAL

SLG

TRANS

SC. 120-C CONT BG.

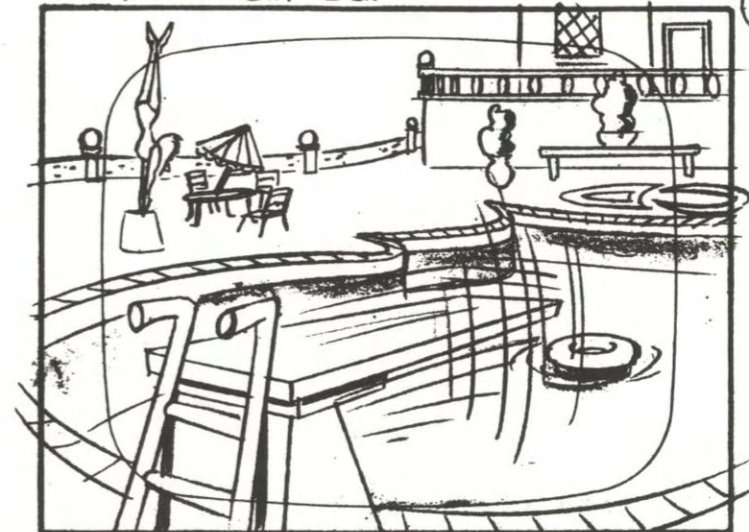

ACTION DIVING BOARD VIBRATES.

DIAL

SLG

TRANS

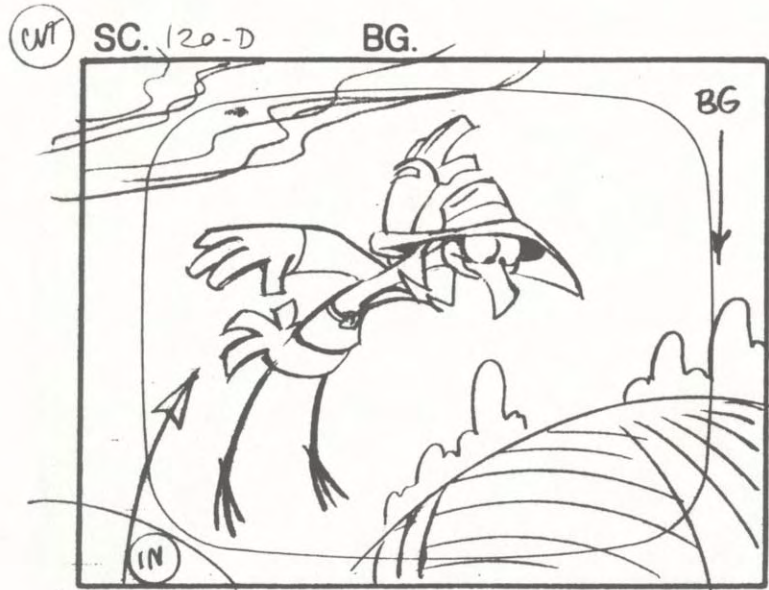

ACTION MARLOWE ARCING INTO VIEW  
BEGIN PAN BG. DOWNWARD.

DIAL

SLG

TRANS

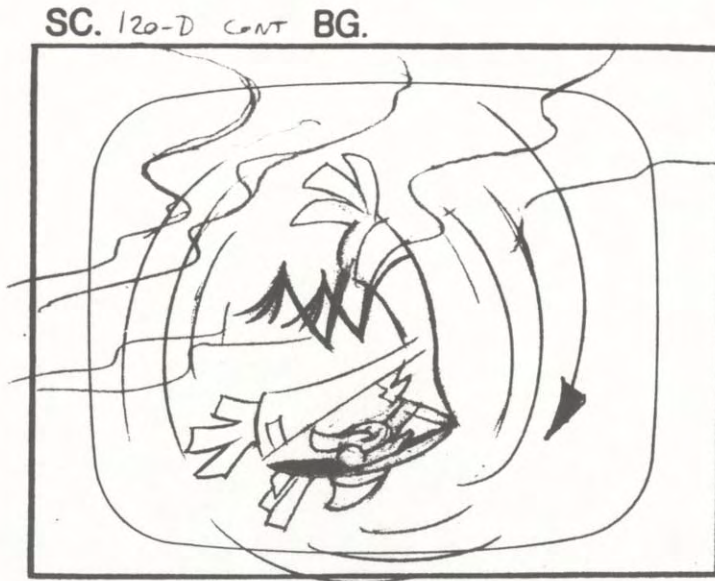

ACTION MARLOWE SOMERSAULTS IN  
MID-AIR. STOP BG. PAN.

DIAL

SLG

TRANS

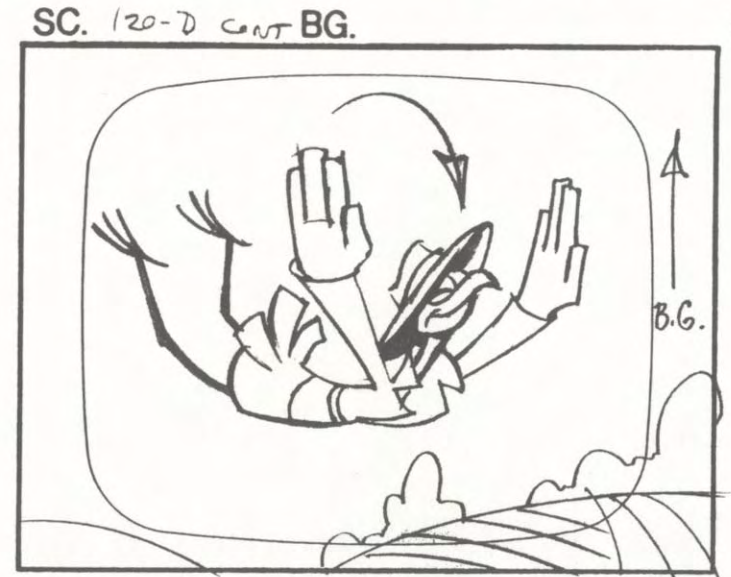

ACTION SWAN DIVE. BEGIN BG. PAN  
UPWARD.

DIAL

SLG

TRANS



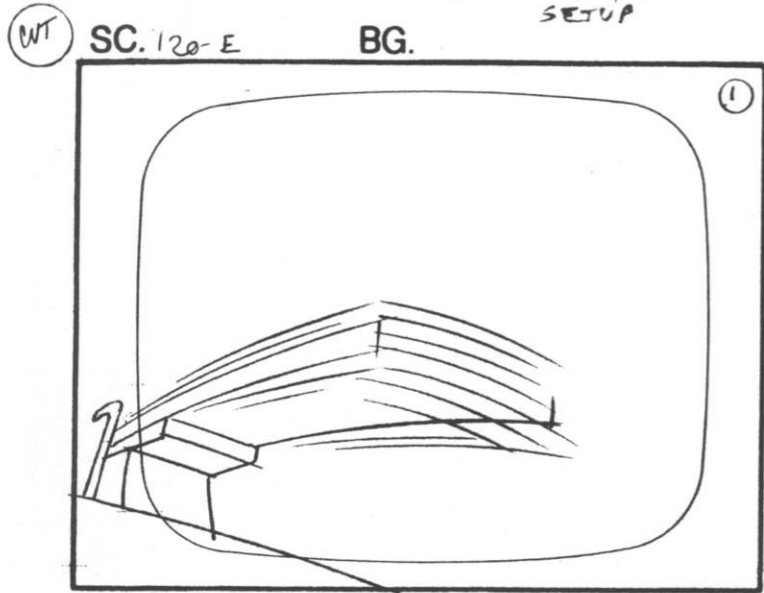

ACTION UPSHOT DIVING BOARD, VIBRATING TO A STOP

DIAL

SLG

TRANS

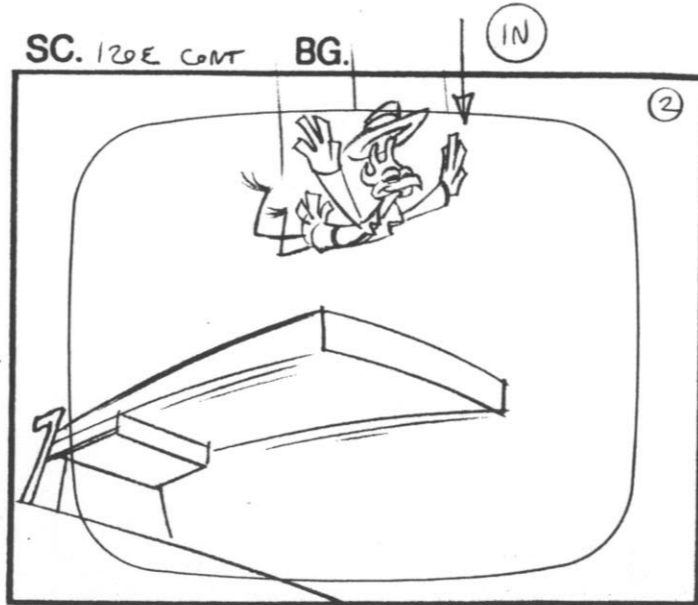

ACTION MARLOWE PLUMMETS INTO VIEW.

DIAL

SLG

TRANS

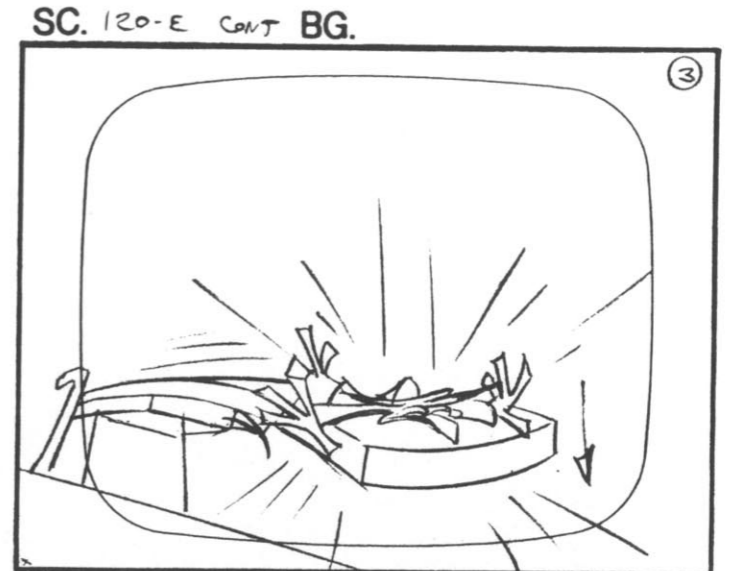

ACTION MARLOWE IMPACTS BOARD.

DIAL

SLG

TRANS

WALT DISNEY PICTURES

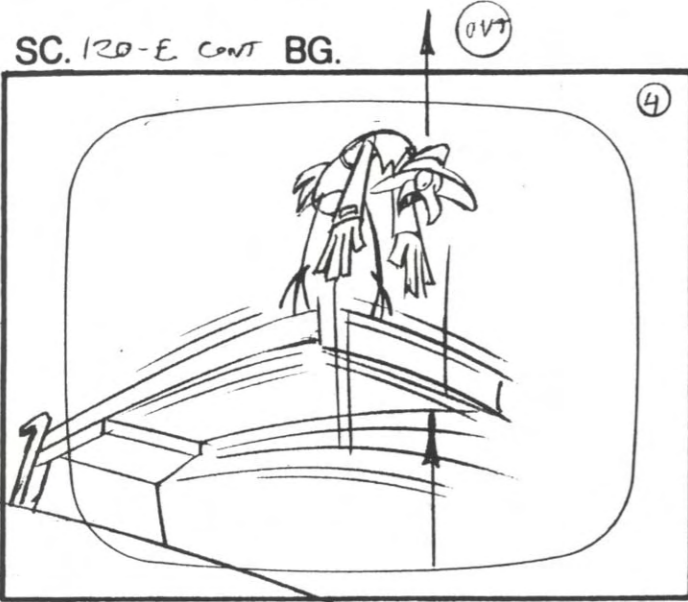

ACTION BOARD BOUNCES MARLOWE OUT OF FRAME.

DIAL

SLG

TRANS

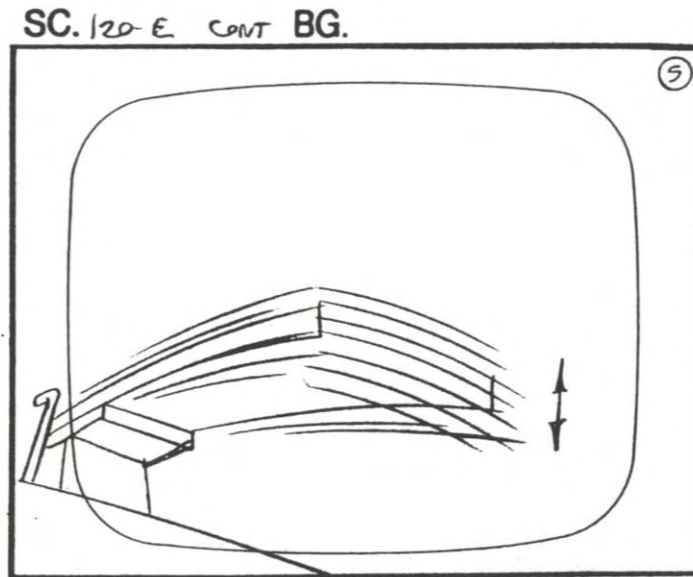

ACTION BOARD VIBRATES TO A STOP.

DIAL

SLG

TRANS

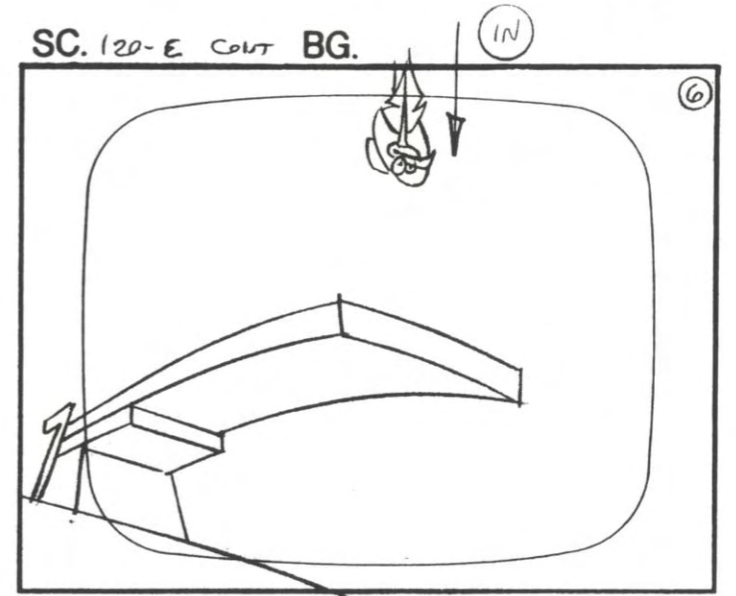

ACTION MARLOWE DROPS HEAD-FIRST INTO VIEW.

DIAL

SLG

TRANS



SC. 120 E CONT BG.

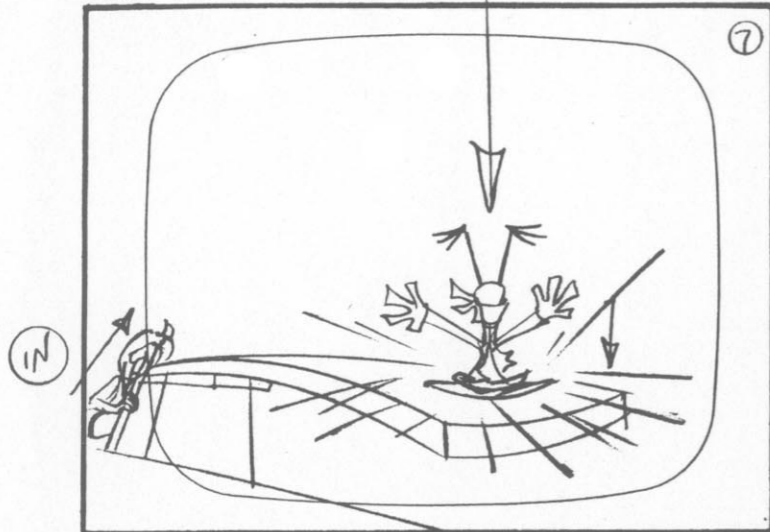

ACTION MARLOWE HITS BOARD AS CRUELLA CLIMBS INTO VIEW.

DIAL

SLG

TRANS

SC. 120-E CONT BG.

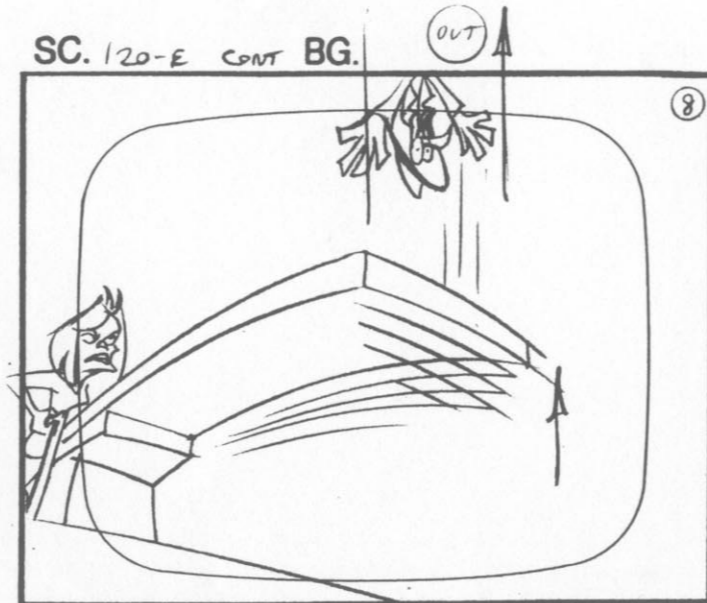

ACTION CRUELLA CLIMBS LADDER AS BOARD BOUNCES MARLOWE OUT OF FRAME.

DIAL

SLG

TRANS

SC. 120-E CONT BG.

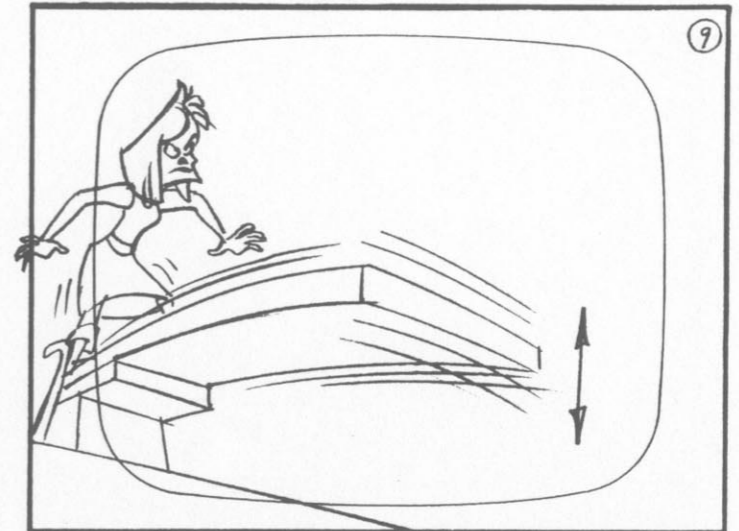

ACTION CRUELLA WATCHES MARLOWE OS. AS BOARD VIBRATES TO A STOP.

DIAL

SLG

TRANS

WALT DISNEY PICTURES

SC. 120-F CONT BG.

(IN)

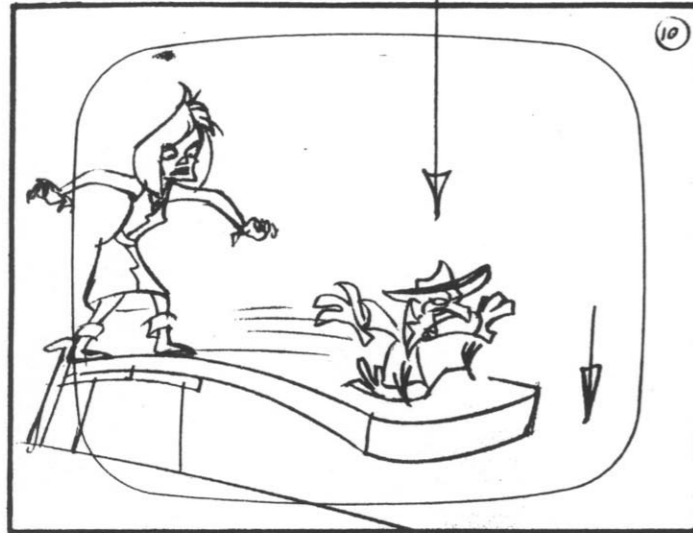

ACTION MARLOWE DROPS INTO VIEW  
ONTO BOARD CRUELLA ADVANCES

DIAL

SLG

TRANS

SC. 120-E CONT BG.

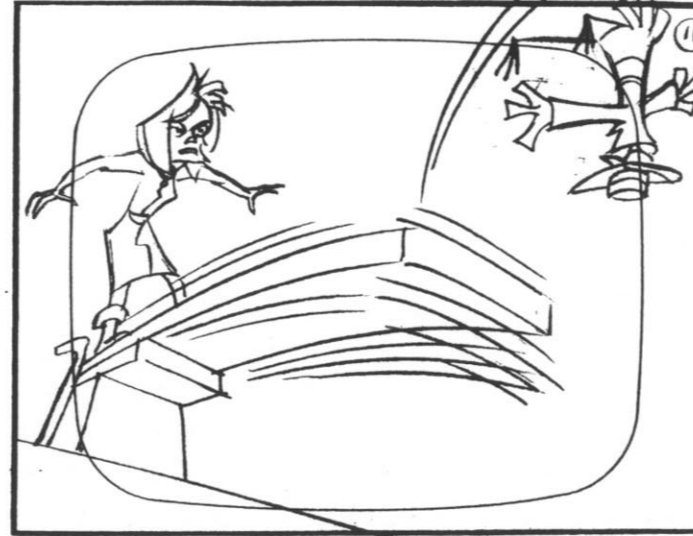

ACTION MARLOWE BOUNCES OFF  
BOARD OUT OF FRAME RIGHT.

DIAL

SLG

TRANS

(CUT)

SC. 120-F BG.

HORIZONTAL  
PAN SETUP

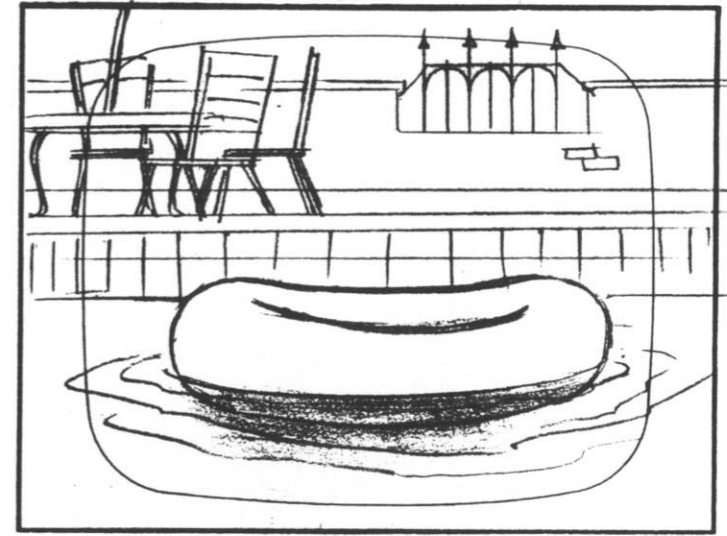

ACTION EXT SWIMMING POOL - INNER TUBE  
FLOATING.

DIAL

SLG

TRANS



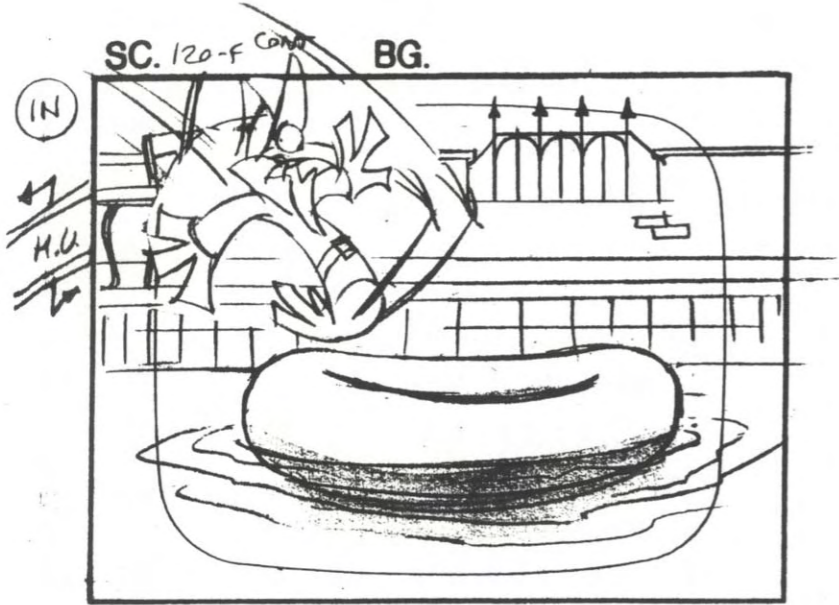

ACTION MARLOWE FLIPS INTO VIEW TOWARD INNER TUBE.

DIAL

SLG

TRANS

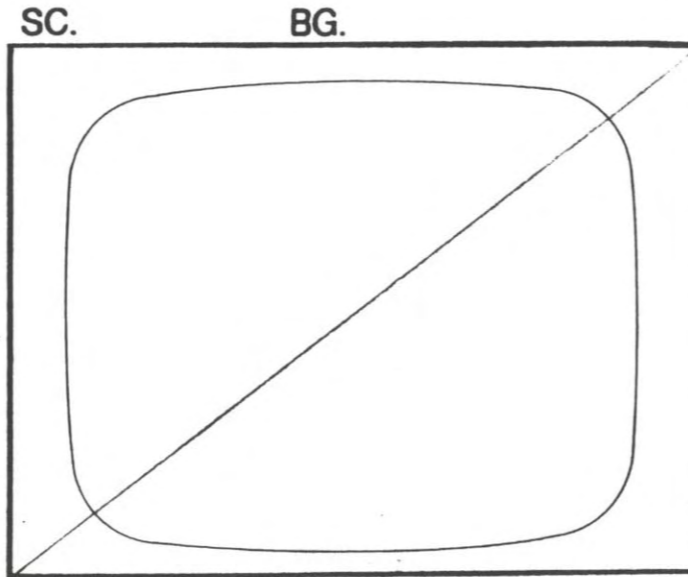

ACTION

DIAL

SLG

TRANS

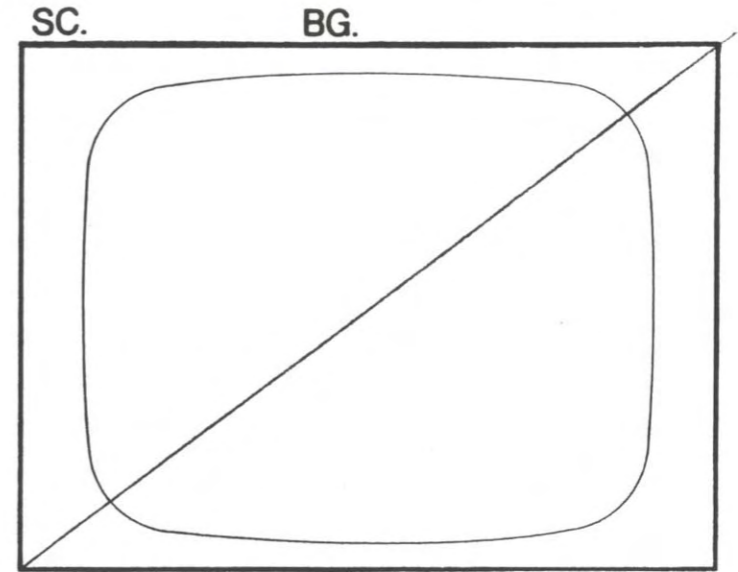

ACTION

DIAL

SLG

TRANS

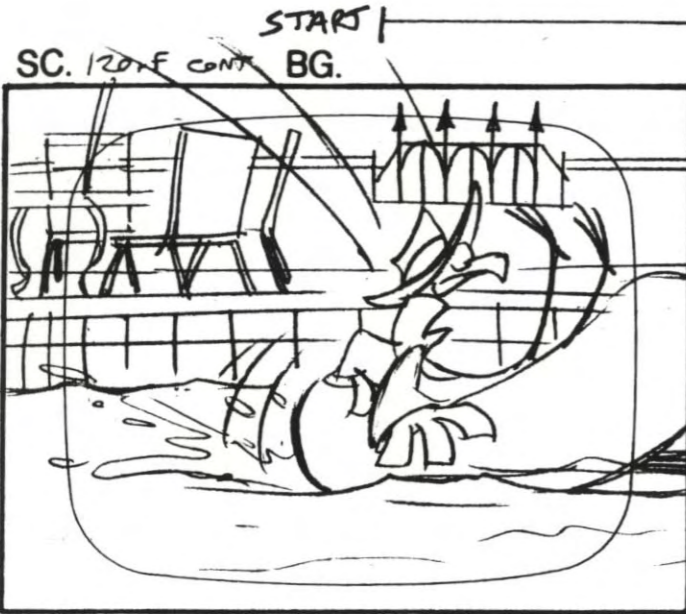

ACTION MARLOWE DROPS ONTO TUBE.

DIAL

SLG

TRANS

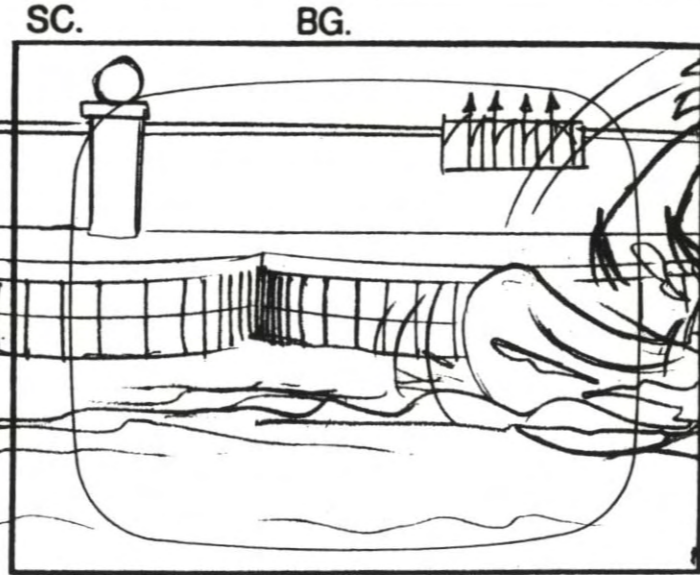

ACTION MOMENTUM PUSHES MARLOWE ACROSS POOL. IMPACTS AGAINST FAR SIDE OF POOL. MARLOWE THROWN OVER SIDE.

DIAL

SLG

TRANS

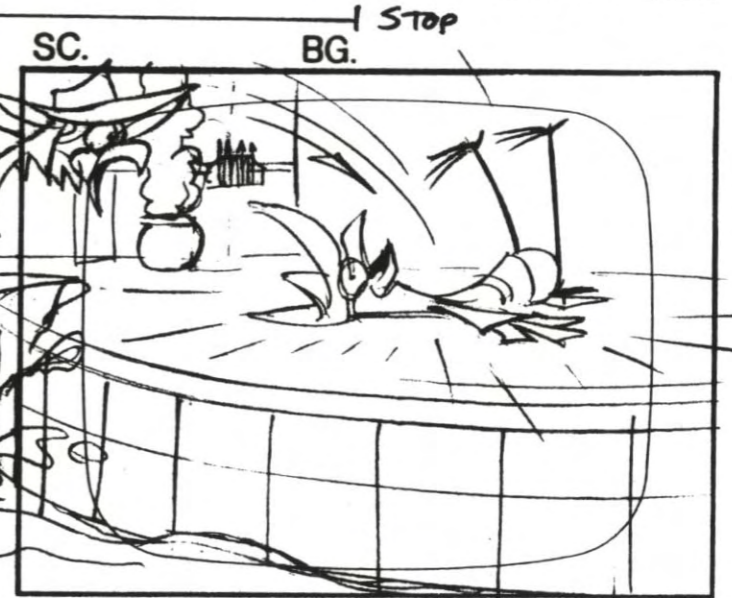

ACTION MARLOWE LANDS SMACK ON BACK.

DIAL

SLG

TRANS



CUT

SC. 120-G

BG.



ACTION UPSHOT DIVING BOARD. CRUELLA ANTICS TO JUMP.

DIAL

SLG

TRANS

120-G GMP  
 SC. SC. SC.  
 START → STOP

SC.

BG.

CUT

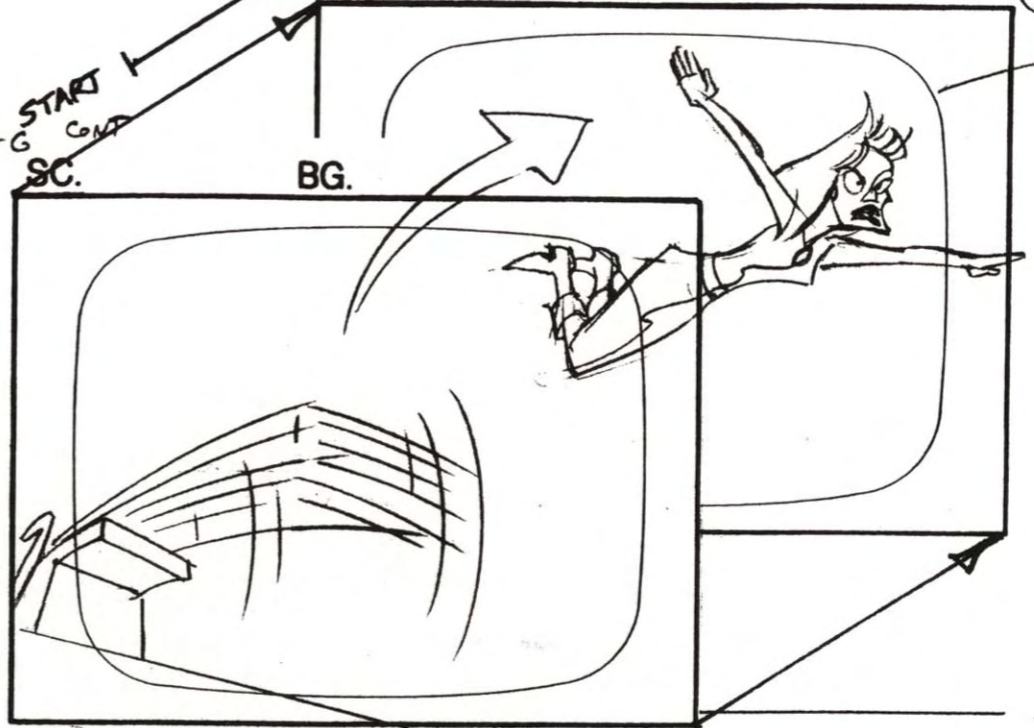

DIAGONAL PAN AS CRUELLA JUMPS OFF BOARD. STOP PAN, SHE FLIES OS. CAMERA RIGHT.

DIAL

SLG

TRANS

SLG

TRANS

(CWT) SC. 120-H BG.

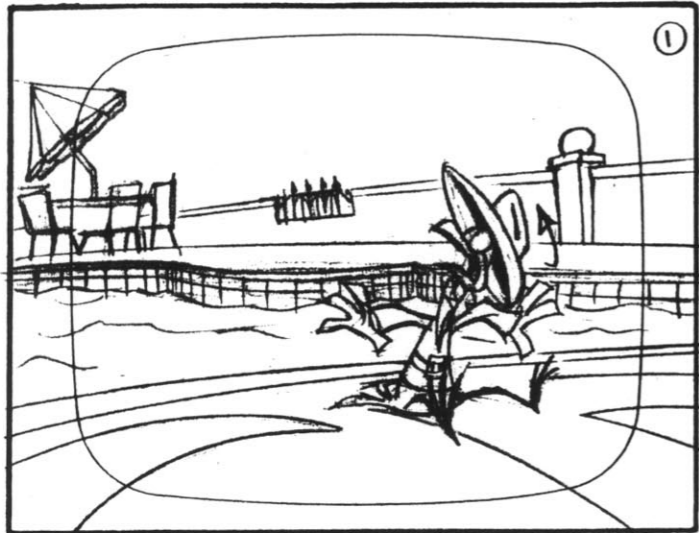

ACTION MARLOWE TURNS, PANICS.

DIAL

SLG

TRANS

SC. 120-H CONT BG.

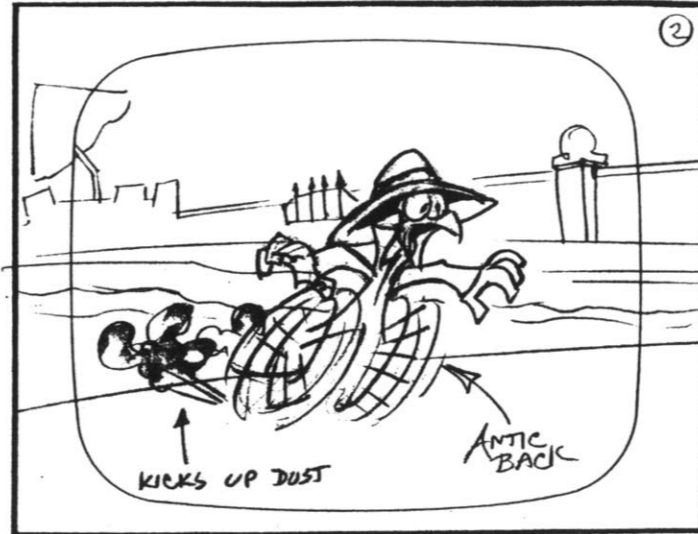

ACTION MARLOWE ANTICS BACK, RUNNING IN PLACE.

DX DUST CLOUD

DIAL

SLG

TRANS

SC. 120-H CONT BG.

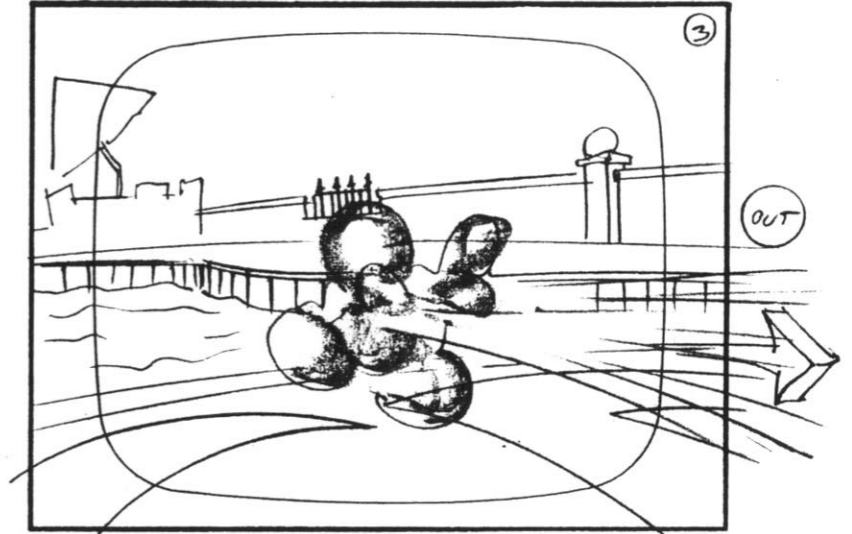

ACTION MARLOWE ZIPS OS. CAMERA RIGHT.

DX DUST CLOUD

DIAL

SLG

TRANS

SC. 120-H CONT BG.

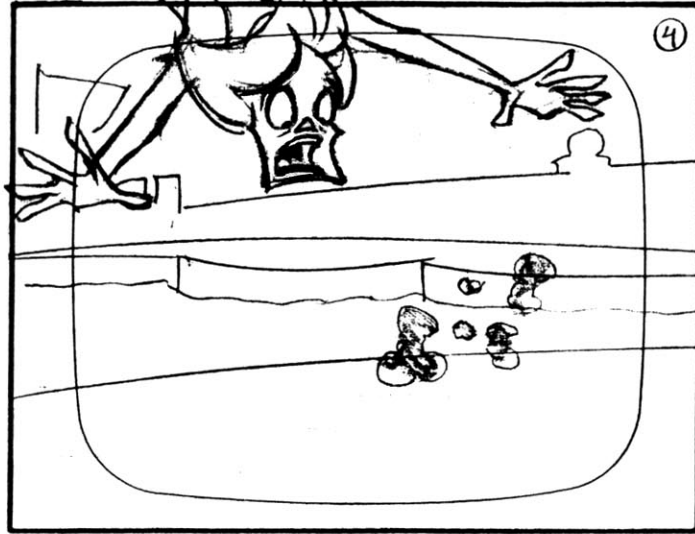

ACTION DUST CLOUD DISSIPATES RAPIDLY AS CRUELLA DROPS TOWARD PAVEMENT.

DIAL

SLG

TRANS

SC. 120-H CONT BG.

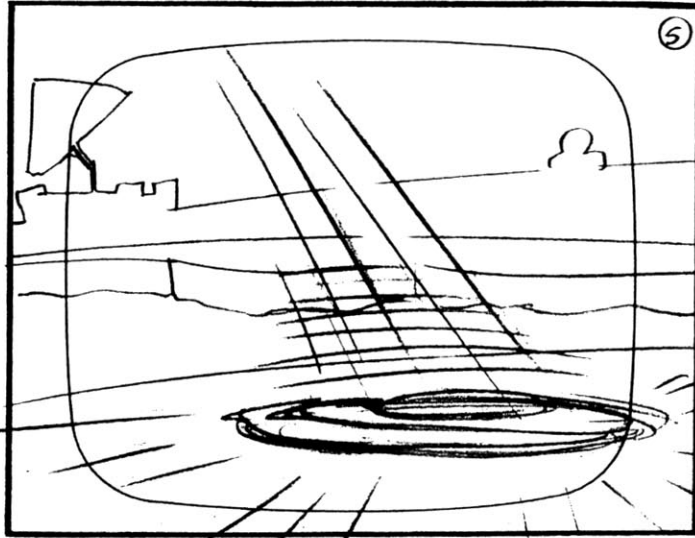

ACTION CRUELLA SMACKS ONTO PAVEMENT, FLATTENS TO PANCAKE-SHAPE.

DIAL

SFX: THWACK!

SLG

TRANS

SC. 120-H CONT BG.

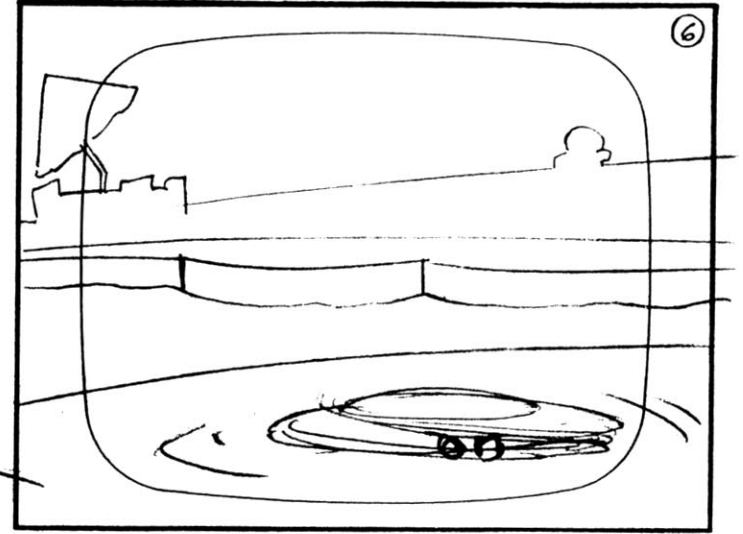

ACTION PANCAKE SETTLES.  
(eyes blink)

DIAL

SLG

TRANS



SC. 120-H CONT BG.

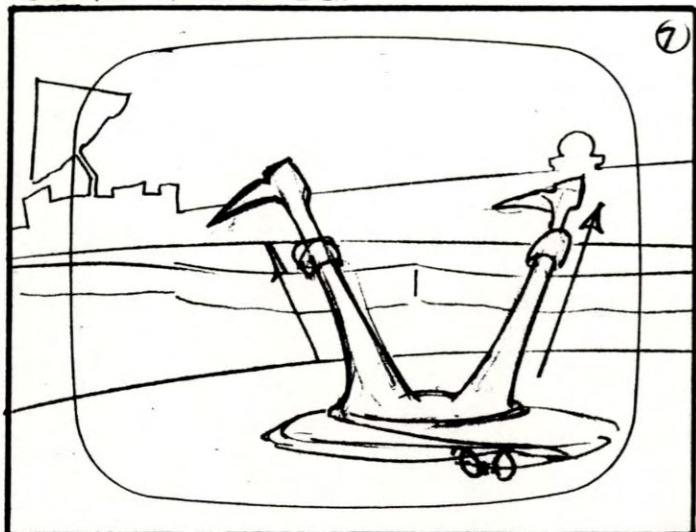

ACTION SUDDENLY, CRUELLA'S LEGS POP OUT OF PANCAKE.

DIAL

SLG

TRANS

SC. 120-H CONT BG.

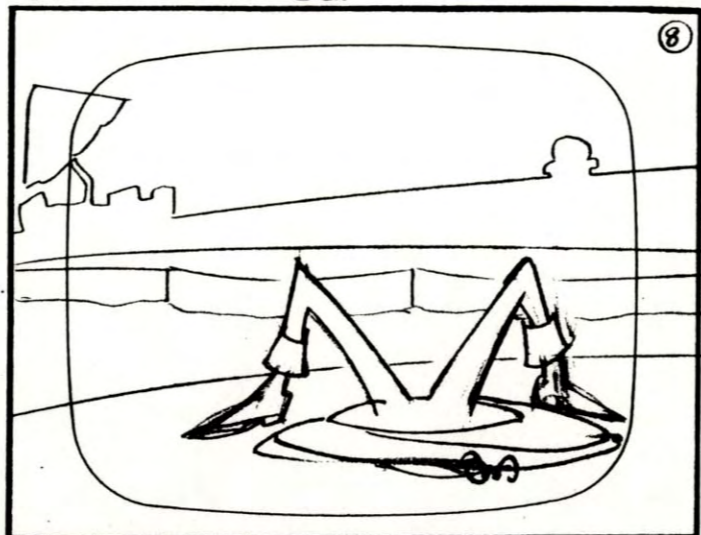

ACTION LEGS BEND, FEET ON GROUND.

DIAL

SLG

TRANS

SC. 120-H CONT BG.

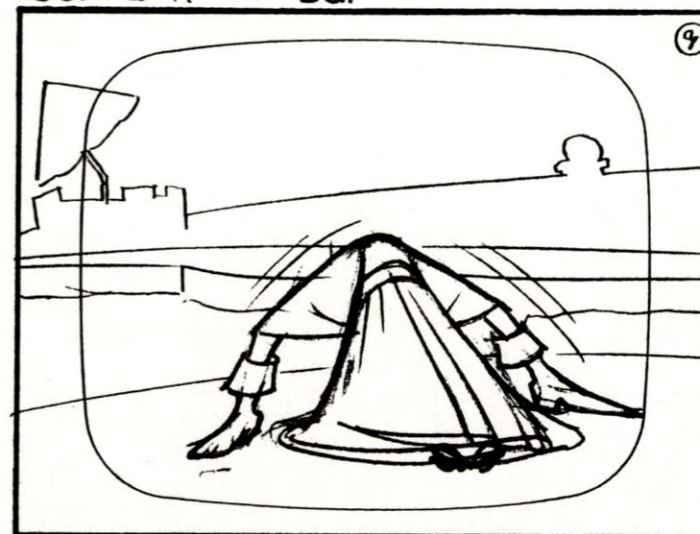

ACTION CRUELLA PUSHES AGAINST GROUND, STRETCHING.

DIAL

SLG

TRANS

SC. 120-K CONT BG.

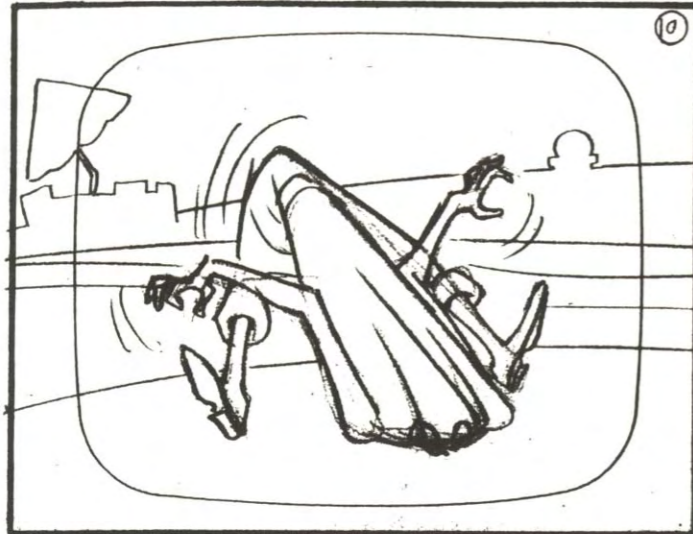

ACTION CRUELLA PULLING OFF GROUND.

DIAL

SLG

TRANS

SC. 120-H CONT BG.

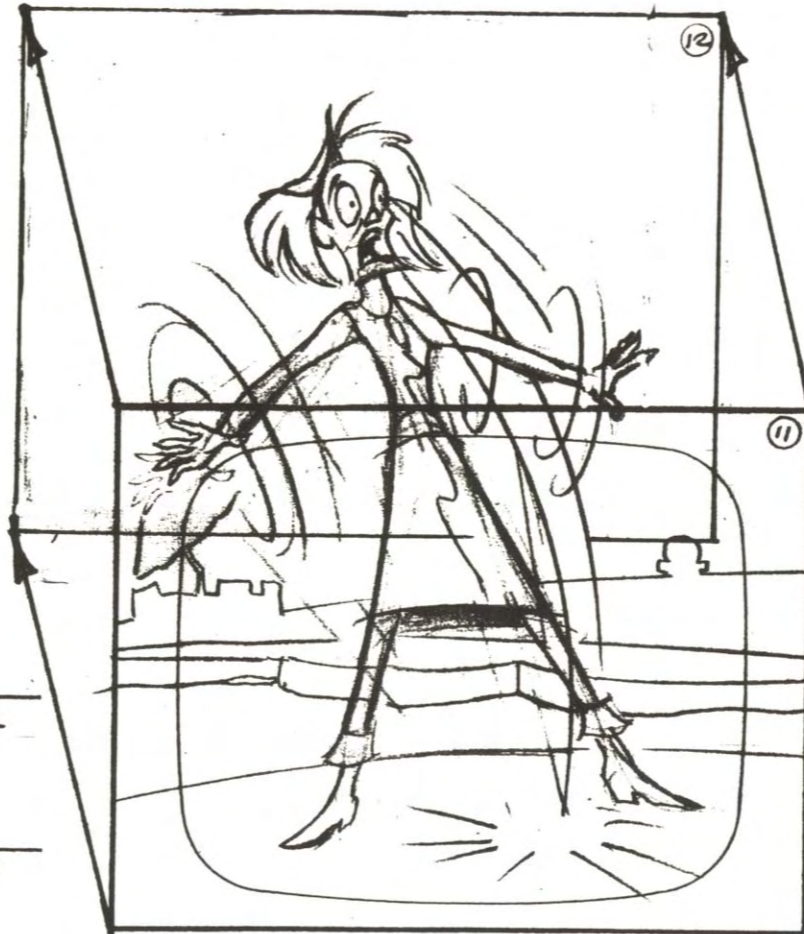

DIAL

SLG

TRANS

SUDDENLY CRUELLA POPS FREE FROM GROUND. PAN UP WITH HER, AS SHE LOSES BALANCE.

TRANS

SC. 120-H CONT BG.

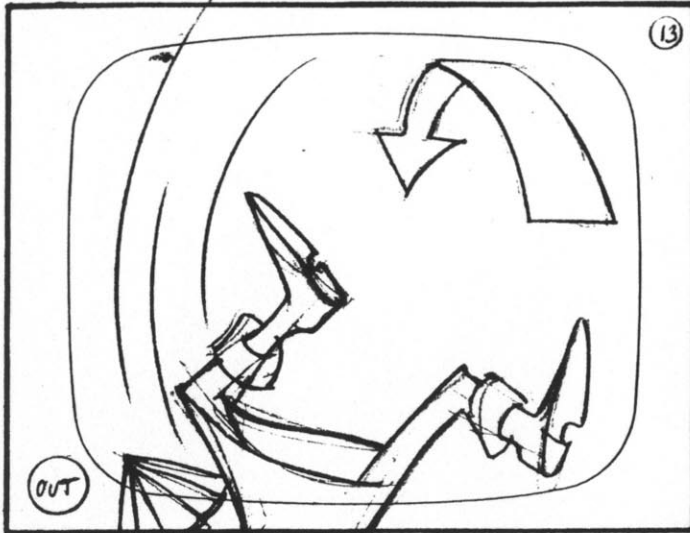

ACTION  
CRUELLA DROPS BACKWARD O.S.

DIAL

SLG

TRANS

SC. 120-H CONT BG.

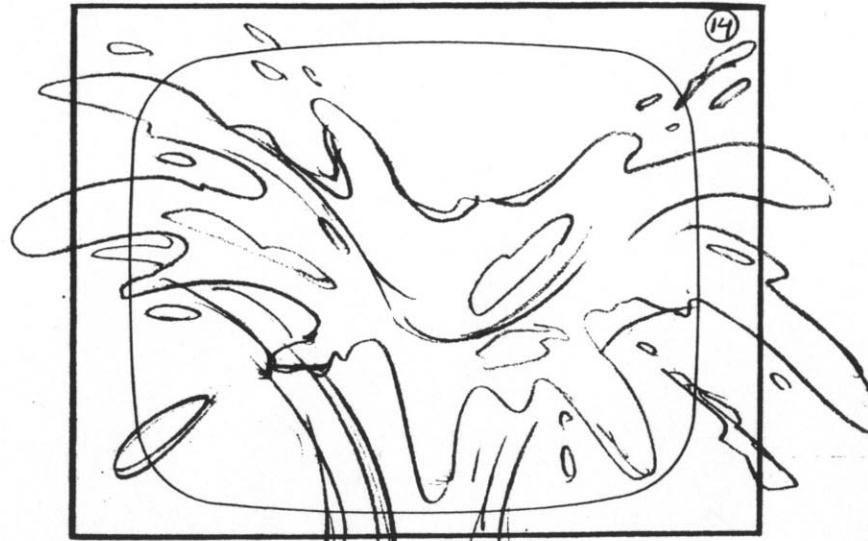

ACTION GIANT SPLASH!

DIAL

SFX: SPLASH!

SLG

TRANS

SC. 120-H CONT BG.

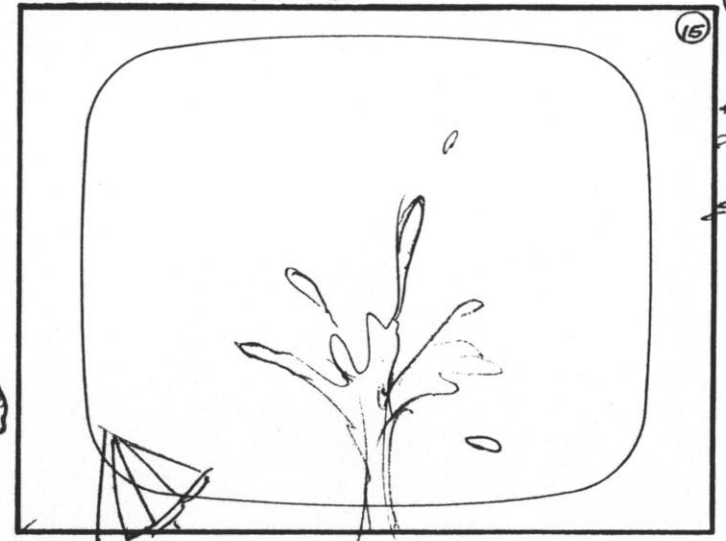

ACTION SECONDARY SPLASH.

DIAL

SFX: SECONDARY SPLASH.

SLG

TRANS



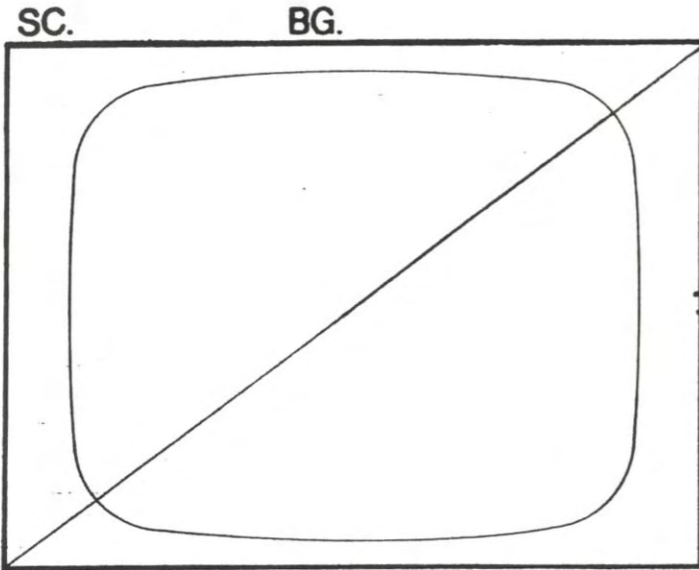

ACTION

DIAL

SLG

TRANS

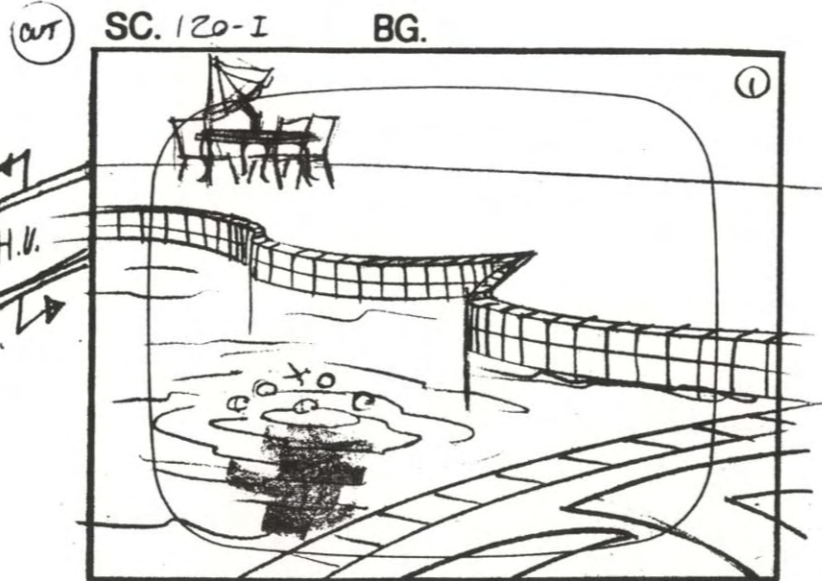

ACTION EXT. POOL. CRUELLA UNDERWATER. BUBBLES RISE AND POP AT SURFACE.

DIAL

SLG

TRANS

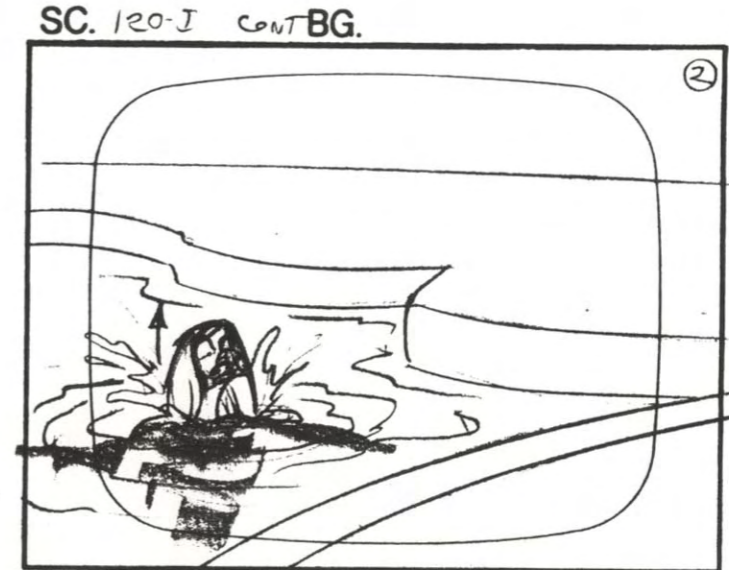

ACTION CRUELLA SURFACES INTO VIEW.

DIAL

SLG

TRANS

SC. 120-I CONT BG.

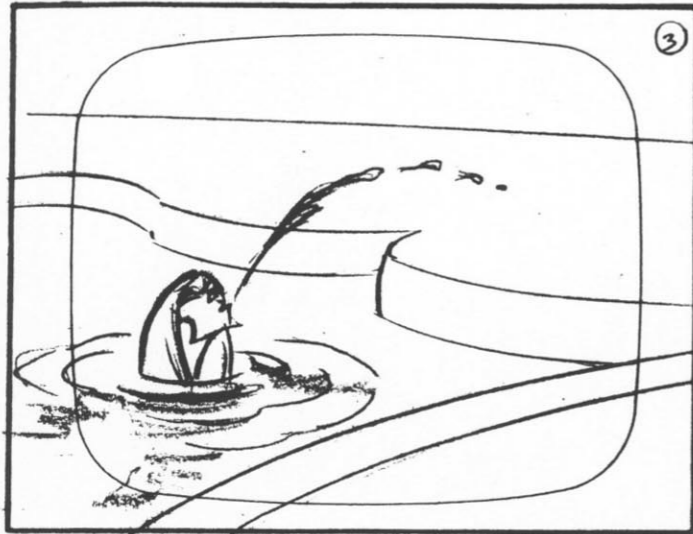

ACTION CRUELLA SPITS OUT WATER.

DIAL

SLG

TRANS

SC. 120-I CONT BG.



ACTION SHE CLIMBS OUT OF POOL.

DIAL

SLG

TRANS

SC. 120-I CONT BG.

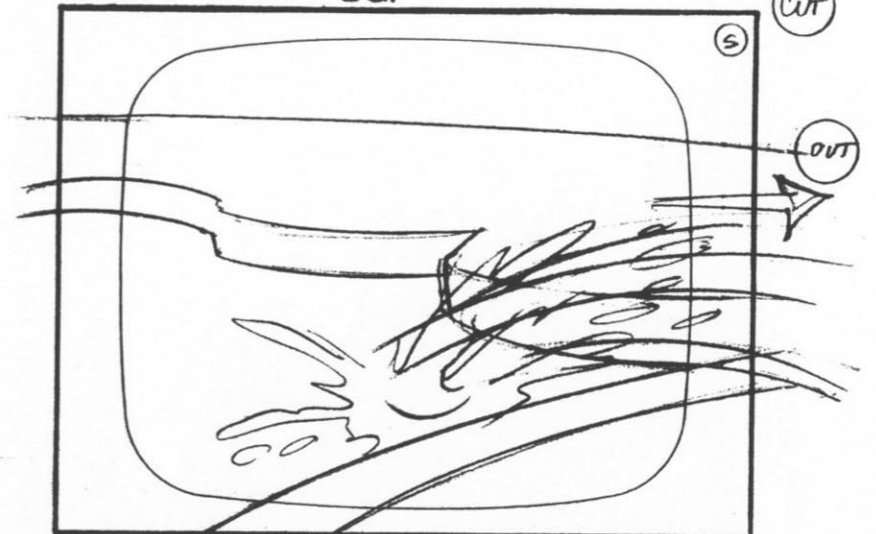

ACTION SHE LUNGES OS CAMERA RIGHT.

DIAL

SLG

TRANS

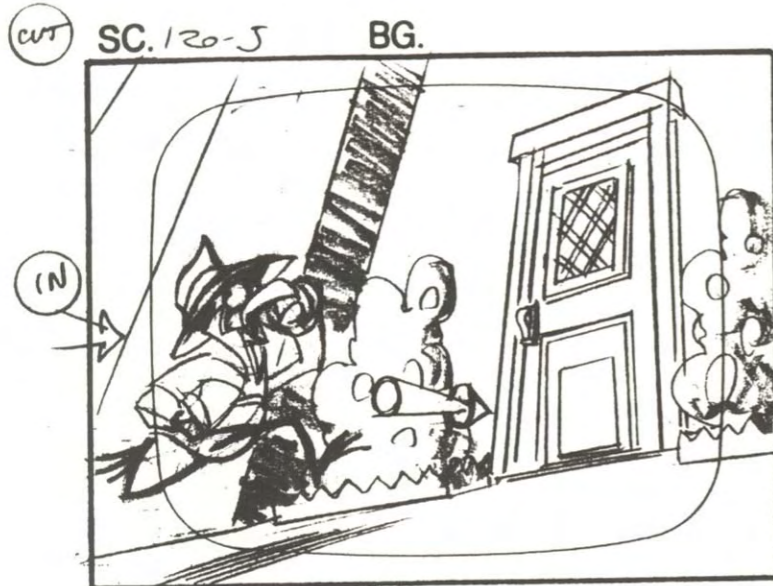

ACTION EXT. KITCHEN DOOR.  
MARLOWE RUNS INTO VIEW  
TOWARD DOOR, DOWNSIZES IN  
PERSPECTIVE.

DIAL

SLG

TRANS

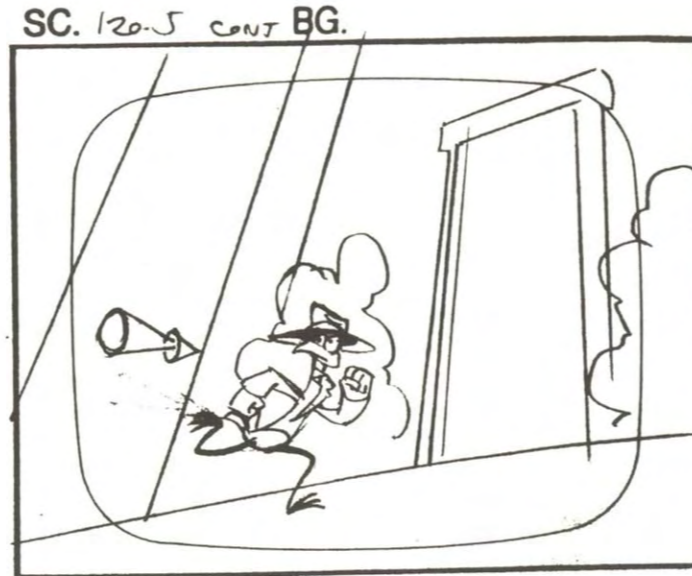

ACTION MARLOWE LOOKS BEHIND.

DIAL

SLG

TRANS

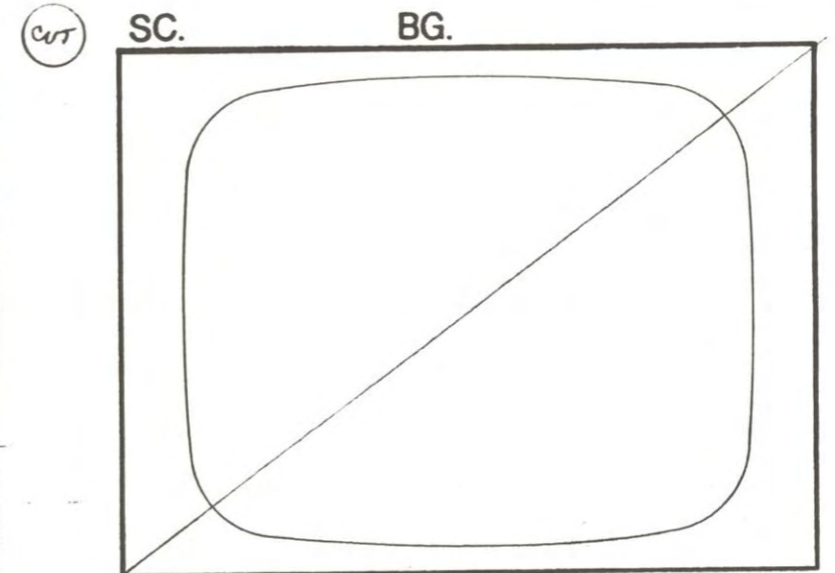

ACTION

DIAL

SLG

TRANS



CUT

SC. 120-K

BG.



ACTION MARLOWE'S P.O.V. - EXT PATIO  
CRUELLA RUNS TOWARD CAMERA.

DIAL

SLG

TRANS

SC.

BG.

ACTION

DIAL

SLG

TRANS

SC. 120-K CONT BG.

CUT



ANGRY CRUELLA LEAPS TOWARD CAMERA.  
DIAGONAL PAN WITH HER.

SLG

TRANS

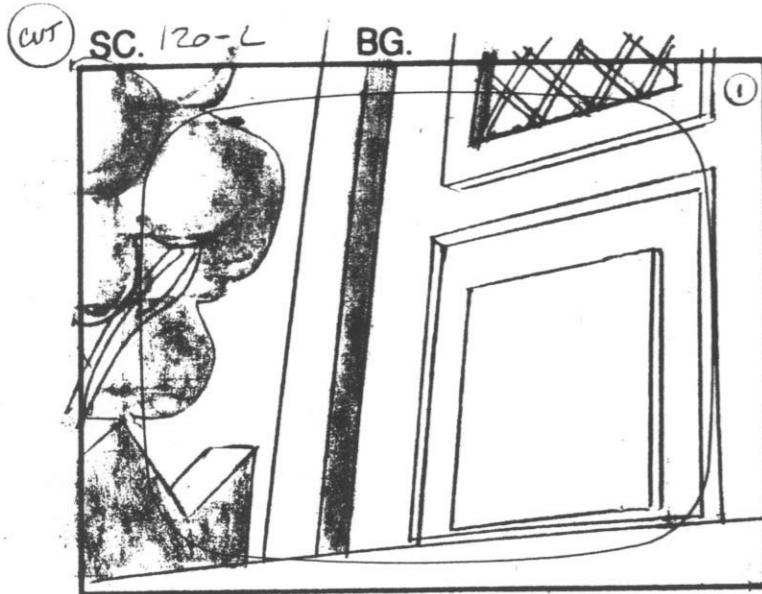

ACTION EXT. KITCHEN DOOR -  
CLOSER ANGLE.

DIAL

SLG

TRANS

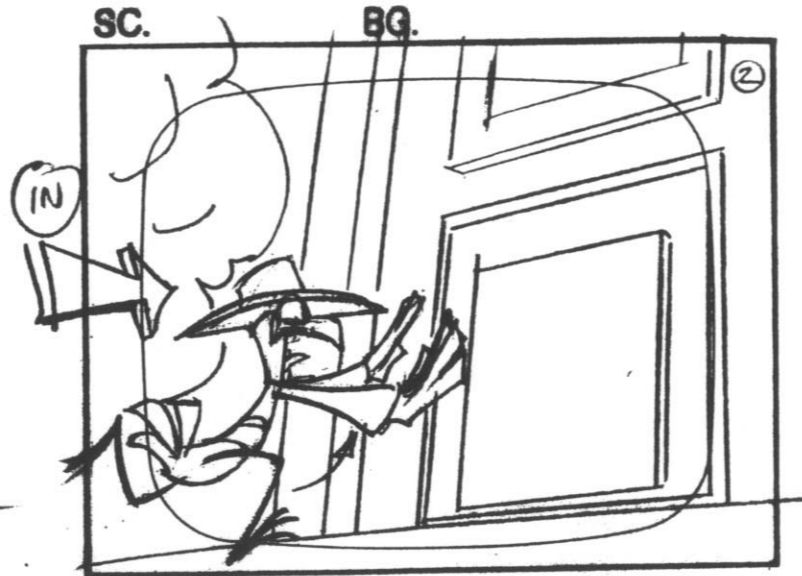

ACTION MARLOWE RUNS INTO VIEW  
TOWARD PET DOOR.

DIAL

SLG

TRANS

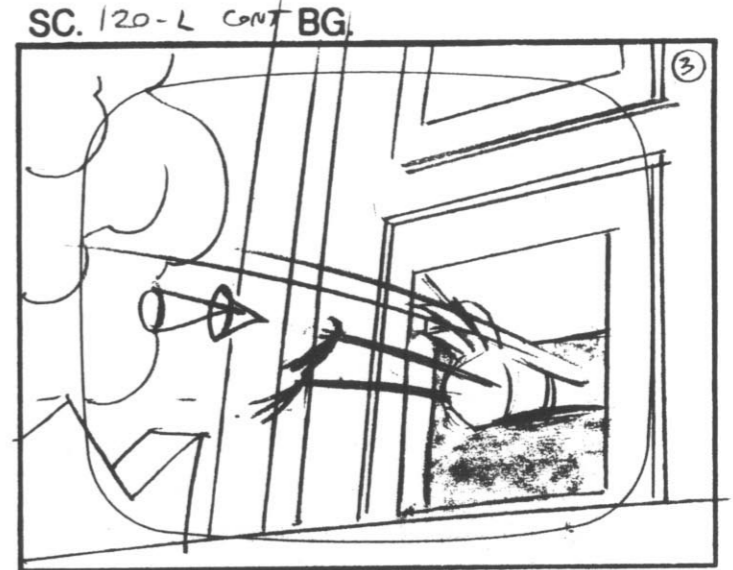

ACTION MARLOWE DIVES THRU PET  
DOOR.

DIAL

SLG

TRANS

SC. 120-L CONT BG.



ACTION PET DOOR SWINGS BACK.

DIAL

SLG

TRANS

SC. 120-L CONT BG.



ACTION CRUELLA DIVES INTO FRAME THROUGH PET DOOR.

DIAL

SLG

TRANS

(CUT)

SC. 120-M BG.

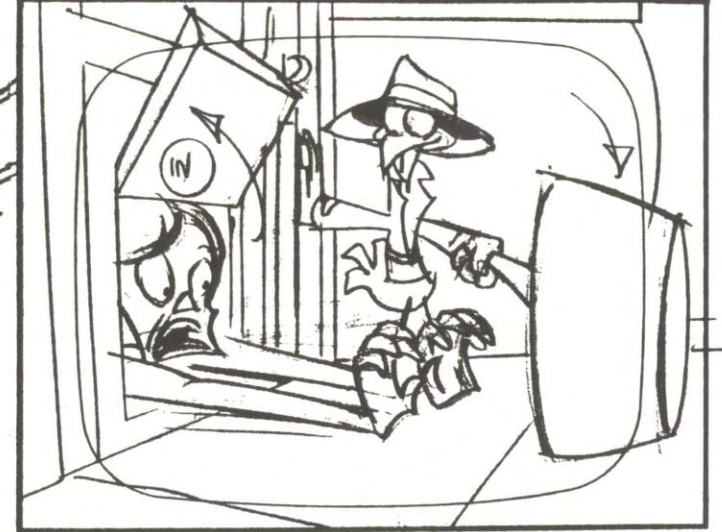

ACTION INT KITCHEN - DAY. MARLOWE SWINGS IN POT IN FRONT OF CRUELLA AS SHE DIVES THROUGH PET DOOR (INTO VIEW)

DIAL

SLG

TRANS



120-M CONT

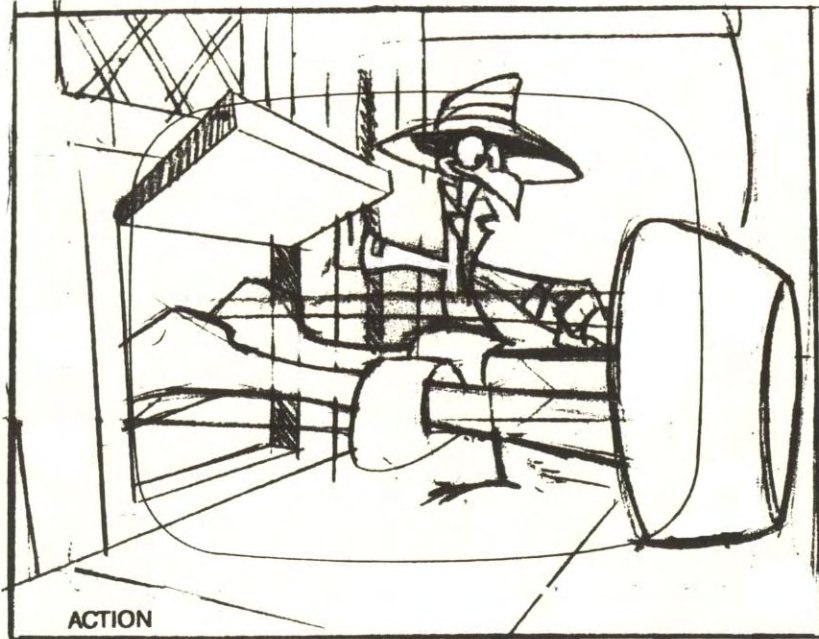

ACTION

MARLOWE NONCHALANTLY HOLDING POT IN FRONT OF PET DOOR. CRUELLA IMPACTS POT.

DIAL

SLG

TRANS

SC. 120-M CONT BG.

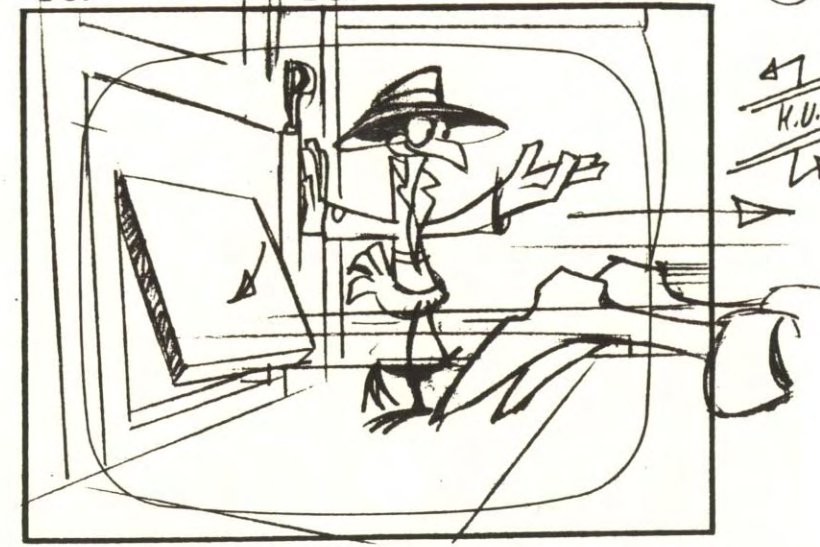

ACTION MOMENTUM CARRIES CRUELLA O.S. CAMERA RIGHT AS MARLOWE RELEASES HANDLE.

DIAL

SLG

TRANS

CUT

SC. 120-N

BG. 4338-084 / 95



ACTION INT. KITCHEN - DAY - CRUELLA FLYING IN PERSPECTIVE TOWARD CAMERA RIGHT.

DIAL

SLG

TRANS

47  
K.U.  
→

WALT DISNEY PICTURES

HORIZONTAL/VERTICAL  
PAN SETUP

SC. 120-N CONT BG.

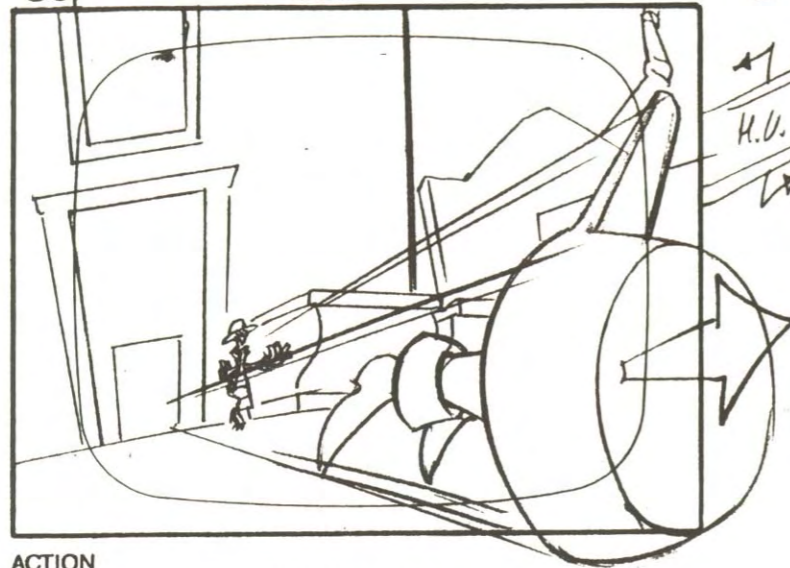

ACTION  
CRUELLA FLIES OS.

DIAL

SLG

TRANS

(CUT)

SC. 120-0 BG.

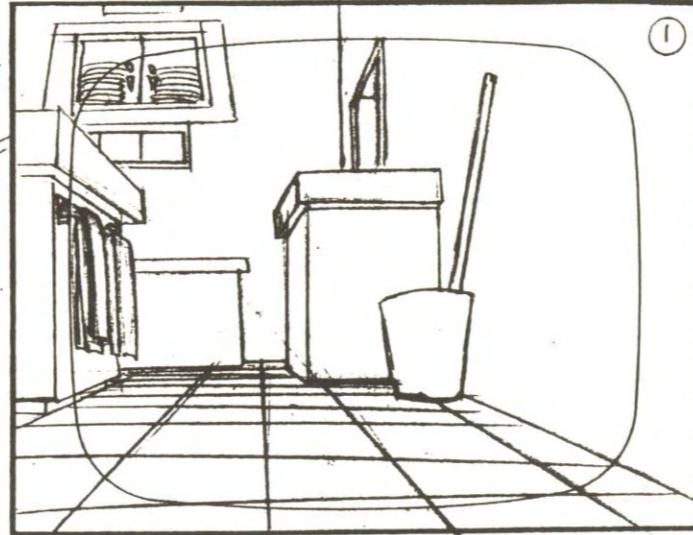

ACTION KITCHEN WALL.

DIAL

SLG

TRANS

SC. 120-0 CONT BG.

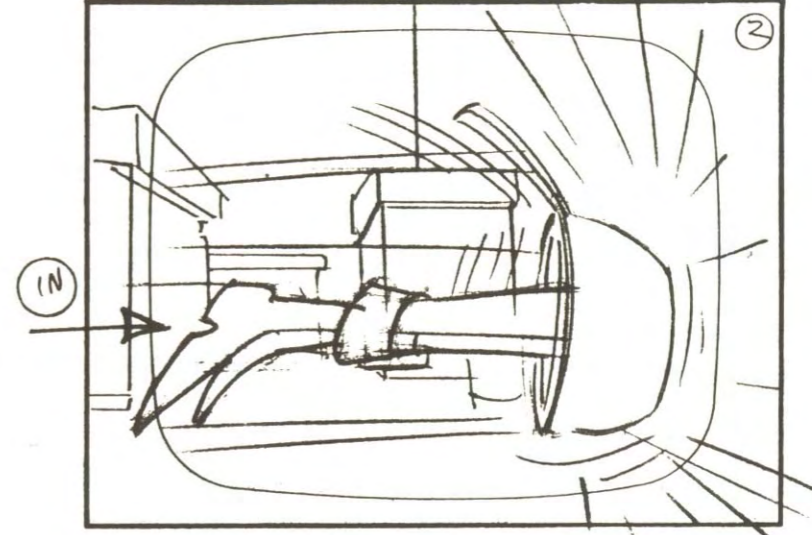

ACTION CRUELLA & POT FLIES INTO  
SCENE, IMPACTS WALL.

DIAL

SLG

TRANS



SC. 120-0 CONT BG.

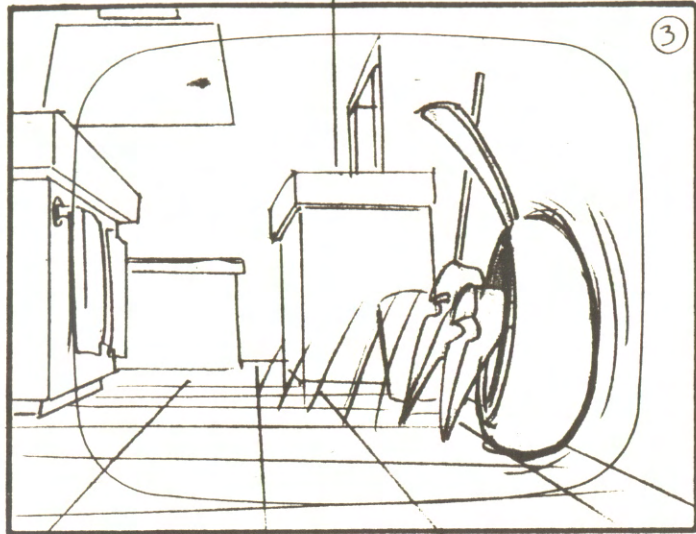

ACTION LEGS COMPRESS INTO POT.

SC. 120-0 CONT BG.

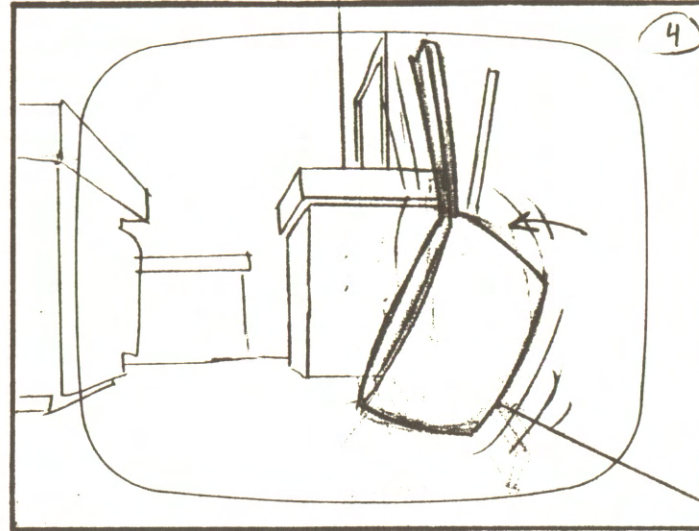

ACTION POT POPS OFF WALL

SC. 120-0 CONT BG.

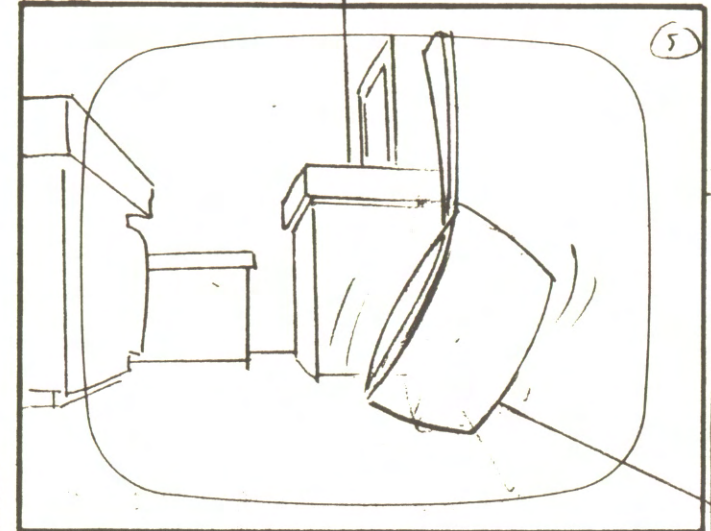

ACTION POT SETTLES.

DIAL

DIAL

DIAL

SLG

SLG

SLG

TRANS

TRANS

TRANS

SC CONT  
→



SC. 120-0 CONT BG.

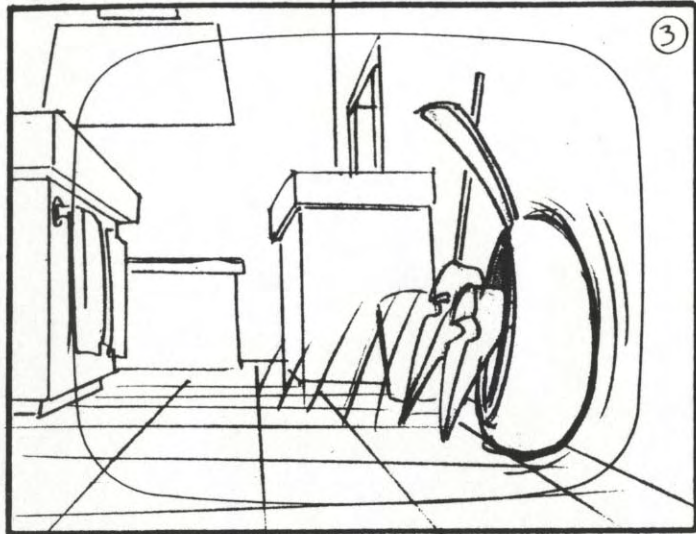

3

ACTION LEGS COMPRESS INTO POT.

DIAL

SLG

TRANS

SC. 120-0 CONT BG.

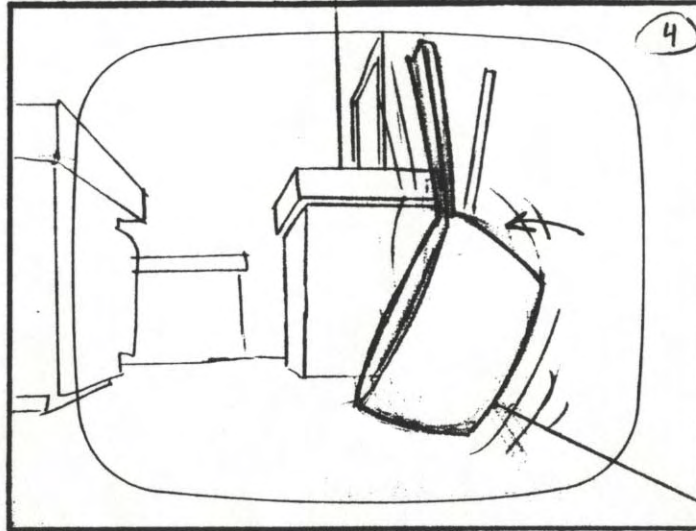

4

ACTION POT POPS OFF WALL

DIAL

SLG

TRANS

SC. 120-0 CONT BG.

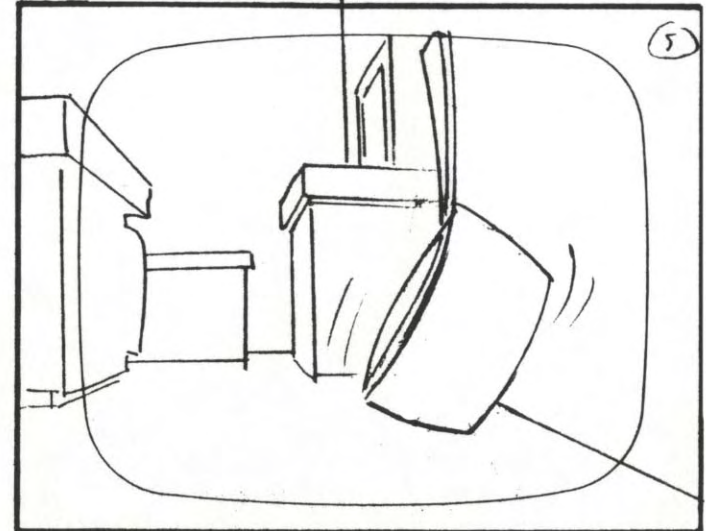

5

ACTION POT SETTLES.

DIAL

SLG

TRANS

SC CONT  
→

STOP | START

SC. 120-0 CONT BG.



ACTION CRUELLA IN POT SHAPE POPS OUT OF POT.

DIAL

SLG

TRANS

SC. CONT. BG.

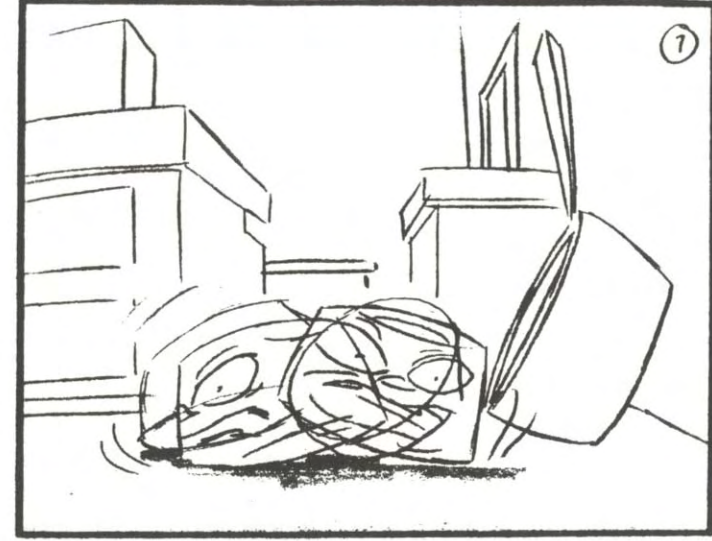

ACTION CRUELLA SPINS ON THE FLOOR LIKE A COIN.

DIAL

SLG

TRANS

SC. 120-0 CONT BG.

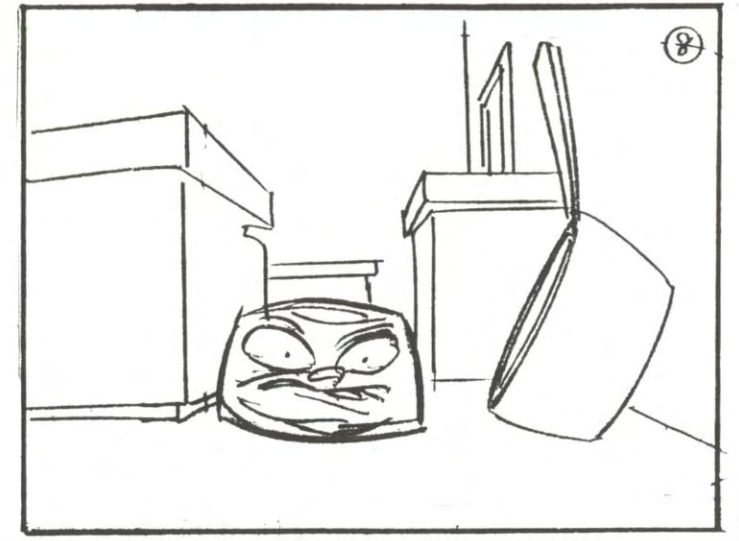

ACTION ACTION CRUELLA SETTLES.

DIAL

SLG

TRANS

SC 120  
↓

SC. 120-0 CONT BG.

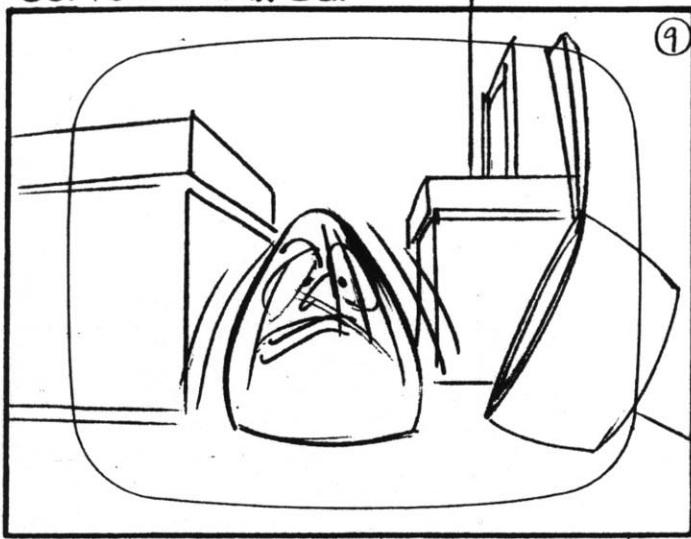

ACTION CRUELLA EXERTS HERSELF, STRETCHES.

DIAL

SLG

TRANS

SC. 120-0 CONT BG.

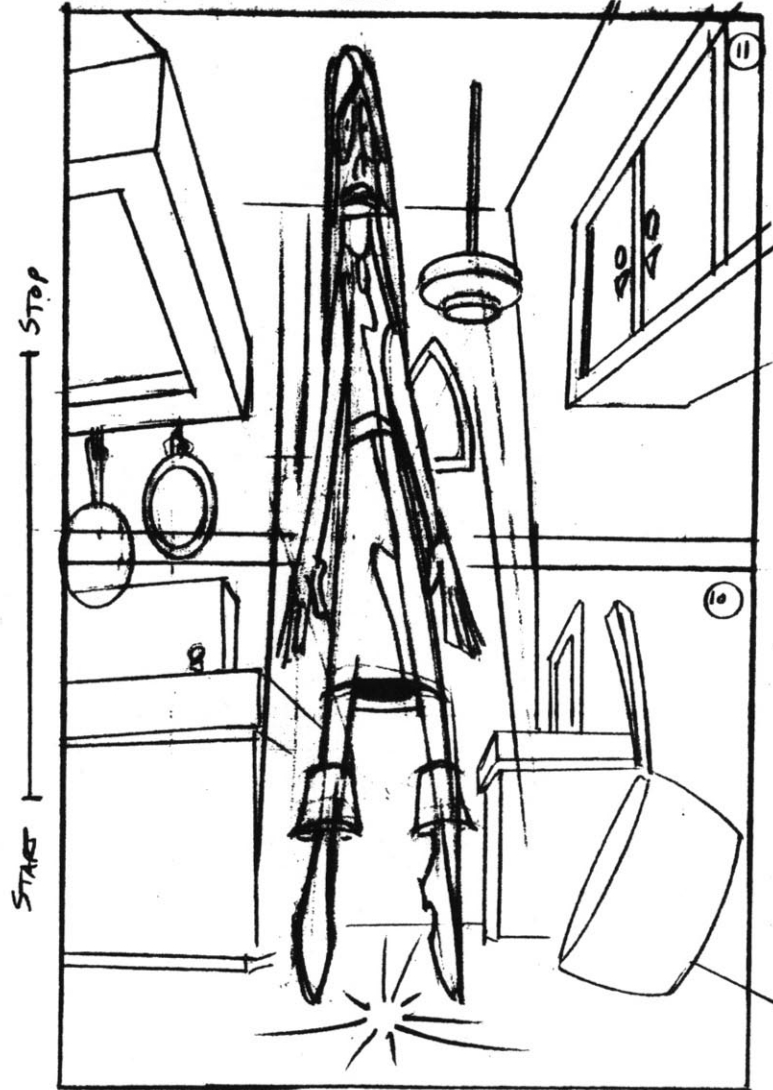

CRUELLA POPS OFF FLOOR. PAN WITH HER.

SC. 120-0 CONT BG.



ACTION CRUELLA RECOVERS BACK TO NORMAL SHAPE.

DIAL

SLG

TRANS



SC. 120-0 CONT BG.

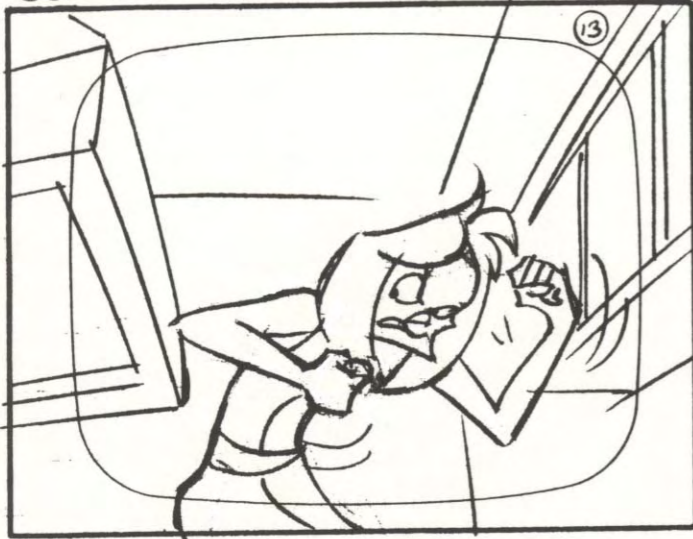

ACTION CRUELLA SEETHES,  
CLENCHES FISTS.

DIAL

SLG

TRANS

SC. 120-0 CONT BG.

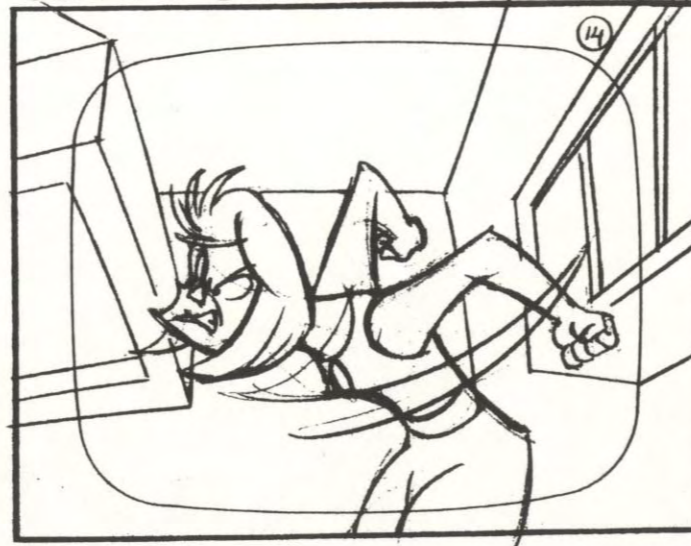

ACTION SHE WHIRLS TO CAMERA LEFT.  
FURIOUS

DIAL

SLG

TRANS

(WT)

SC. 120-P BG.



ACTION MARLOWE 'TAKES' IN FEAR.

DIAL

SLG

TRANS

SC. 120-P CONT BG.

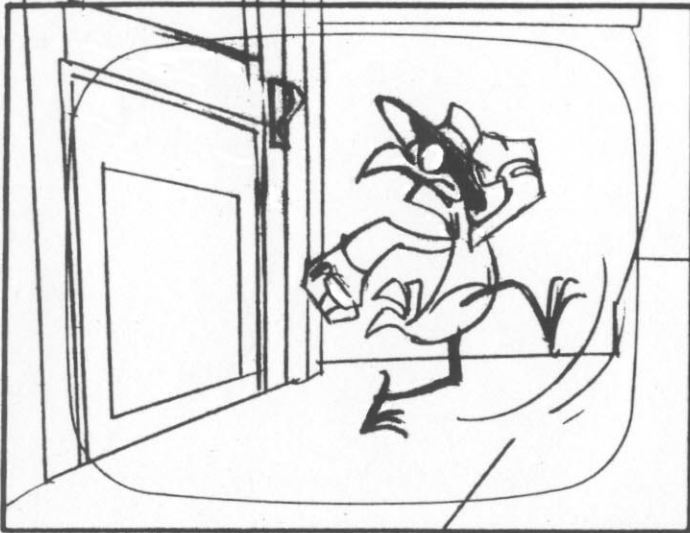

ACTION MARLOWE ANTICS TO RUN.

DIAL

SLG

TRANS

SC. 120-P CONT BG.

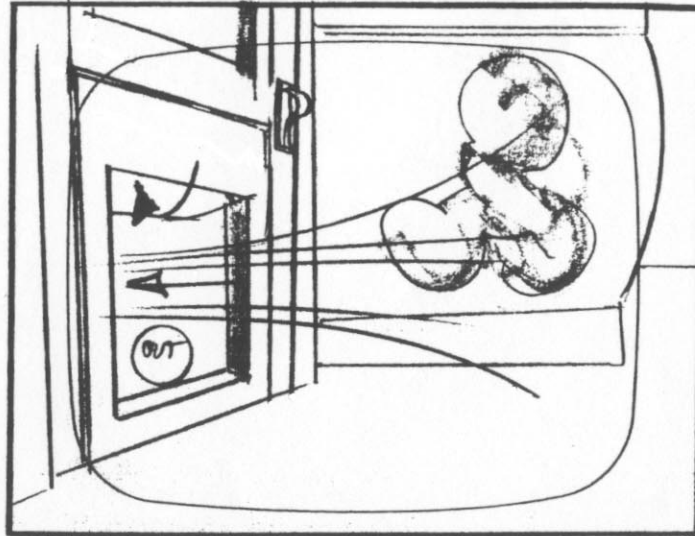

ACTION MARLOWE ZIPS OS. THRU PET DOOR.

DIAL

SLG

TRANS

CUT

SC. 120-Q BG.

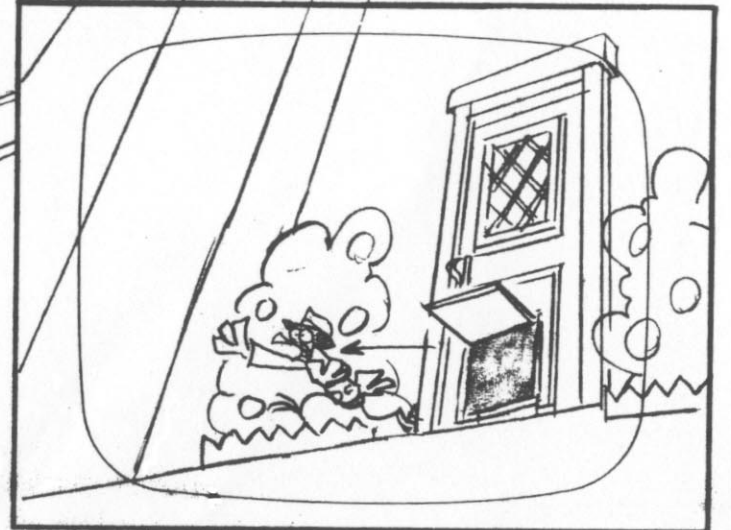

ACTION EXT. KITCHEN DOOR, MARLOWE ROOMS OUTSIDE.

DIAL

SLG

TRANS

SC CONT